

Tools and Maintenance

04

section contents

<i>Books and Manuals</i>	04-16	<i>Mixing and Measuring Bottles</i>	04-13
<i>Carb Synchronizer</i>	04-9	<i>Octane Booster</i>	04-13
<i>Carburetor Leak Detector</i>	04-9	<i>Piston Light</i>	04-11
<i>Clutch Pullers</i>	04-2	<i>Piston Pin Puller</i>	04-9
<i>Clutch Tools</i>	04-4	<i>Shock Spring Tools</i>	04-9
<i>Compression Tester</i>	04-10	<i>Snap Ring Pliers</i>	04-9
<i>Degree Wheel</i>	04-10	<i>Snowmobile Oils and Lubricants</i> ..	04-13
<i>Dial indicator Tool</i>	04-10	<i>Snowmobile Lifts and Dollys</i>	04-12
<i>Digital Caliper</i>	04-10	<i>Throttle Position Sensor Tester</i>	04-11
<i>Exhaust Spring Removal Tools</i>	04-10	<i>Timing Lights</i>	04-10
<i>Flywheel Pullers</i>	04-10	<i>Toolkits</i>	04-15
<i>Impact Screwdriver</i>	04-15	<i>Track Clip Tools</i>	04-9
<i>Isopropyl Gas Line Antifreeze</i>	04-13	<i>Tension Adjustment Scale</i>	04-8
<i>LiquiVac</i>	04-13		

(G)

Part# 725-202 2 piece puller Price \$53.65
 Part# 725-201 1 piece puller Price \$29.95

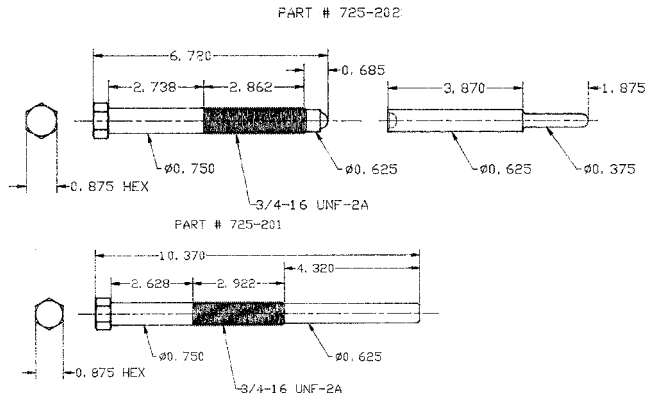

- | | | |
|-----------------------------------|-----------------------------|---|
| '00-'01 340 Deluxe, 340 Dlx-Tour. | '98 Indy 440 | '93-'95 Star Lite |
| '99-'00 340 Touring | '89-'98 Indy 500 | '93-'97 Storm, RMK, SKS |
| '96-'97 440L/C | '00-'01 Indy 500 | '94-'97 Supersport |
| '93-'95 440SKS | '00-'01 Indy 500 Classic | '89-'92 Supertrack |
| '87 440SKS | '85-'87 Indy 600 | '84-'98 Trail Indy's, RMK, SKS, Dlx |
| '97 440XC | '88-'92 Indy 650 | '96-'99 Trail Touring |
| '92-'97 440XCR | '91-'98 Indy Lite, Lite-Dlx | '96-'99 Transport |
| '90-'97 500L/C, Carb, EFI | '93-'96 Lite-GT | '96-'98 Ultra's, RMK, SKS, Touring, SPX |
| '96-'99 500RMK | '87-'89 Longtrack Reverse | '90-'93 Widetrack |
| '89-'97 500SKS | '85-'87 Longtrack | '94-'97 Widetrack GT |
| '85-'87 600 Indy's | '91-'97 RXL650's | '94-'01 Widetrack LX |
| '88-'92 650 Indy's | '87-'99 Sport | '97 XCF |
| '00 600 Triumph | '90-'92 Sport-GT | '95-'98 XCR600 |
| '97 600XC | '95-'99 Sport Tour. | '98 XCR700 |
| '89-'98 Classic's | '89 Sport Tour. | '93-'99 XLT's, RMK, SKS, Tour., |
| '00-'01 Classic's | '86-'90 Sprint, Sprint ES | '93-'99 XLT's, LTD, Classic |
| '96-'01 Classic Tour. | '87-'90 Star | |
| '93-'94 Classic Tour. | '85 Star | |
| '85-'91 Indy 400 | '85-'86 Star SS | |
| '92-'95 Indy 440 | '87-'90 Startrack | |

Part# 725-203 Price \$40.22 Fits: Quick Shift Clutches
 Polaris P-85 & P-90 Deep Bore

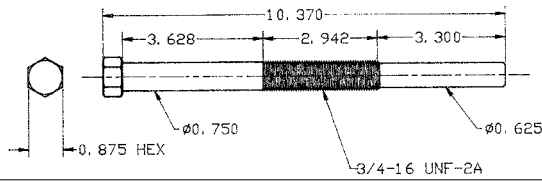

Part# 725-206 Price \$53.65

- '97-'98 US Twins
- '99 600XC, 600XC-SP
- '97-'99 700RMK
- '97 700SKS
- '99 700SKS
- '98-'99 700XC

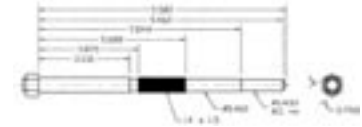

Part# 725-207 Price \$33.52

- '99-'03 440 XC Edge
- '00-'01 500RMK
- '00 500SKS
- '00-'01 500XC, 500XC-SP
- '00 600XC, Dlx
- '01 600 Classic Tour.
- '00-'01 600XC-SP
- '00 700XC, Dlx
- '01 800XC
- '01 600 Edge-X
- '01 700 Classic
- '00-'01 700XC-SP
- '99-'03 800XCR
- '00-'01 600RMK
- '00-'01 700RMK
- '99 700 XCR
- '00-'03 US Twins
- '00 600 Touring
- '00-'01 700SKS
- '00-'01 800RMK
- 500/600/700/800

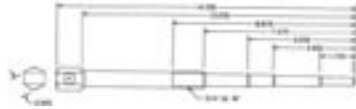

Part# 725-208 Price \$33.52

- '00-'01 Sport Touring
- '00-'01 Supersport
- '00-'01 Trail, Trail-RMK
- '00 Trail Touring

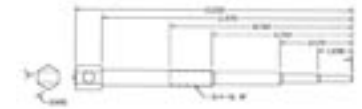

Part# 725-402 Price \$40.22
 oem #529-00021-00

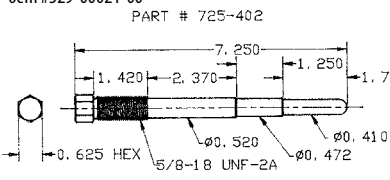

- | | | | | |
|----------------------------|----------------------------------|------------------------------|---------------------|----------------------|
| '83-'87 Alpine | '81 Blizzard Mx | '85-'86 Formula Mx | '87 Safari | '85 Safari Grand Lux |
| '79-'81 Blizzard 5500 | '80-'92 Elan | '85 Formula Plus | '84-'86 Safari 377, | '89 Safari Saga |
| '84 Blizzard 5500 MX | '79 Elan 250, Elan Dlx. | '86 Formula SP | Safari 377E | '89-'90 Safari Scout |
| '82 Blizzard 5500 MX | '78-'82 Elite | '85 Formula SS | '88 Safari 377E | '89 Safari Scout E |
| '78 Blizzard 6500 Plus | '78-'79 Everest 340, Everest 440 | '85 Mirage III | '86 Safari 447 | '84 Safari SS-25 |
| '79-'81 Blizzard 7500 | '79 Everest 444 | '87-'89 Nordik 50, Nordik 60 | '84 Safari 447 | '87 Skandic |
| '79-'82 Blizzard 9500 | '80-'82 Everest 500 | '91 Nordik 50, Nordik 60 | '84-'85 Safari 477 | '78 TNT F/A TNT F/C |
| '83-'84 Blizzard 9700 | '80-'82 Everest LC | '78-'79 Olympique | '86 Safari GL LC | |
| '79 Blizzard Cross Country | '78 Everest LC | '78 RV 340 | | |

Part# 725-401 Puller w/pin Price \$33.52
 oem #529-0028-00 & 529-0030-00

Part# 725-411 (replacement pin) Price \$21.46

- | | | |
|-----------------------|--------------------------|---------------------------|
| '84 Citation | '85-'87 Citation LS, LSE | '84-'87 Skandic R |
| '87 Citation | '81 Citation SS | '83 Skandic 277, 377 |
| '80 Citation | '81-'82 Nordik | '85-'87 Tundra, Tundra LT |
| '81-'83 Citation 3500 | '82 Skandic | '87 Tundra LTS |
| '81-'83 Citation 4500 | '84-'86 Skandic | |

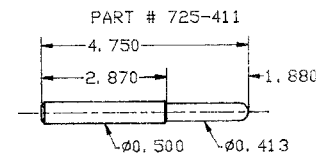
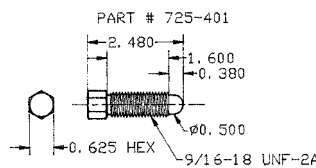

Part# 725-412 Price \$46.92
 oem #420-4760-30

- '88 Alpine
- '87-'88 Escapade
- '89 Formula Mach-1
- '86-'87 Formula Plus
- '88 Safari 503, 503R
- '89 Safari Cheyenne
- '89 Safari Escapade
- '89 Safari Voyager
- '87-'88 Stratos

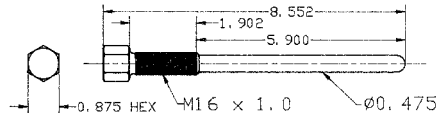

Part# 725-204 Price \$49.49
 oem #529-0250-00

- '93 Mach-Z 780 with an OEM F1 Comet Clutch 40mm PTO Taper)

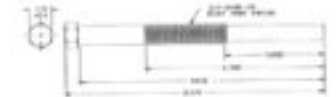

Part# 725-413 Price \$46.92

'93-'94 Alpine II	'94 Formula Mach-Z	'96 Formuls SLS	'99 Formula 500
'90-'91 Alpine II	'88-'94 Formula MX	'99 Formula ST	'95 Grand Touring 470
'90 Alpine IV	'93-'94 Formula MXZ	'95-'96 Formula STX	'96-'98 Grand Touring 500
'91 Cheyenne	'89-'93 Formula Plus ,X,E, XTC,EFI	'99 Formula STX	'95-'96 Grand Touring 580
'97-'00 Formula 500,Dlx,	'95-'99 Formula SL	'91-'92 Formula XTC	'94-'99 Grand Touring 583
'97-'99 Formula 583		'95-'99 Formula Z-583	
'91 Formula MX			
'93 Formula Grand Tour.			
'90-'92 Formula Mach-1,Mach-1-XTC			
'91 Formula Mach-1X			

'94 Mach-1,Mach-1 GT,XTC,	'90-'92 Safari GLX	'98 Skandic Super Widetrack
'95 MX	'90-'94 Safari L	'00 Skandic SWT,WT
'99-'00 MXZ440	'90-'91 Safari LC	'95-'98 Skandic Widetrack
'96 MXZ440	'92 Safari LCE	'94 Summit 470
'97-'98 MXZ440F	'90-'92 Safari LE	'96-'98 Summit 500
'01 MXZ440F, MXZ500F	'90-'91 Safari LX,LXE	'01 Summit 500F
'97 MXZ440LC	'94 Safari Rally E	'94-'98 Summit 583
'98 MXZ500	'94 Skandic	'99-'00 Touring LE
'96-'98 MXZ583	'95-'00 Skandic 500	'96-'97 Touring LE
'93 Safari 503 Rally	'94 Skandic 503R, 503R-SLT	'99-'00 Touring SLE
'90 Safari Cheyenne	'92 Skandic II, IIR	'95-'97 Touring SLE
'93-'94 Safari Dlx.	'92 Skandic II 377,377R	
	'93 Skandic II 503, 503R	

Part# 725-414 Price \$29.959.95
oem #529-0224-00

'01 Formula 500 Dlx.	'97-'00 Grand Touring SE	'98 MXZ440LC
'00-'01 Formula 600 Dlx.	'95-'99 Mach-1	'98 Skandic Widetrack LC
'99 Formula 670 Dlx.	'98-'00 Mach-1R	'99 Summit 500
'00-'01 Formula 700 Dlx.	'95-'01 Mach Z's	'99-'01 Summit 600
'96-'98 Formula III	'96-'99 MXZ670, MXZ670HO	'95-'98 Summit 670, Summit-X670
'98-'99 Formula III 600	'00 MXZ700	'99-'01 Summit 700
'98-'00 Formula III 700	'01 MXZ800	'01 Summit 800
'99-'00 Formula III 800	'01 MXZX440	'00 Touring 500LC
'93 Formula Mach-1, XTC	'00 MXZX440LC	
'95-'96 Formula SS		
'00 Formula Z 600		
'98-'99 Formula Z 670		
'00 Formula Z 700		
'01 Grand Touring 500		
'99 Grand Touring 500		
'00-'01 Grand Touring 600		
'98-'01 Grand Touring 700		

Part# 725-501 Price \$29.95
Fits all Kawasaki Built Clutches
'78-'82 Intruder, Invader, Ltd

Part# 725-601 Price \$40.22
Fits all Free Air Yamahas Except Splined Crank Models

Part# 725-602 Price \$33.52
Yamaha SRX & Exciter Models
Threads 18mm x 1.5mm

'81 EC340E	'85-'88 Enticer	'79-'83 Enticer 340	'79-'81 Exciter 440	'83-'88 Excel III	'80-'81 SS440	'81 SR540	'79-'81 SRX440
------------	-----------------	---------------------	---------------------	-------------------	---------------	-----------	----------------

Part# 725-603 Price \$29.959.95
Yamaha 1985-2001 YPZ & YXR Clutches
oem# Y5-01881-1

'87-'01 Bravo	'99 CS340EC	'90 Enticer	'92-'95 Enticer	'89 Enticer 400	'85-'91 SRV's	'96-'98 Venture 480	'85 V-max
'85-'86 Excel V	'88 Excel V	'90 Excel V	'97-'01 Mountain Max's	'89-'90 Ovation	'92-'98 Ovation	'84-'01 Phazer's	'92 V-max
'88 Excel V	'90 Excel V	'97-'01 Mountain Max's	'89-'90 Ovation	'92-'98 Ovation	'84-'01 Phazer's		'91 V-max 500
'92-'95 Enticer	'89 Enticer 400	'85-'91 SRV's	'96-'98 Venture 480	'85 V-max			'92 V-max
'85-'86 Excel V	'88 Excel V	'90 Excel V	'97-'01 Mountain Max's	'89-'90 Ovation	'92-'98 Ovation	'84-'01 Phazer's	'91 V-max 500
'88 Excel V	'90 Excel V	'97-'01 Mountain Max's	'89-'90 Ovation	'92-'98 Ovation	'84-'01 Phazer's		'97-'01 V-max 500
'92-'95 Enticer	'89 Enticer 400	'85-'91 SRV's	'96-'98 Venture 480	'85 V-max			'97-'99 V-max 600
'85-'86 Excel V	'88 Excel V	'90 Excel V	'97-'01 Mountain Max's	'89-'90 Ovation	'92-'98 Ovation	'84-'01 Phazer's	'97-'00 V-max 700
'88 Excel V	'90 Excel V	'97-'01 Mountain Max's	'89-'90 Ovation	'92-'98 Ovation	'84-'01 Phazer's		'00-'01 V-Max 500,600,700
'92-'95 Enticer	'89 Enticer 400	'85-'91 SRV's	'96-'98 Venture 480	'85 V-max			'00 SX700R, SX600R
'85-'86 Excel V	'88 Excel V	'90 Excel V	'97-'01 Mountain Max's	'89-'90 Ovation	'92-'98 Ovation	'84-'01 Phazer's	
'88 Excel V	'90 Excel V	'97-'01 Mountain Max's	'89-'90 Ovation	'92-'98 Ovation	'84-'01 Phazer's		
'92-'95 Enticer	'89 Enticer 400	'85-'91 SRV's	'96-'98 Venture 480	'85 V-max			
'85-'86 Excel V	'88 Excel V	'90 Excel V	'97-'01 Mountain Max's	'89-'90 Ovation	'92-'98 Ovation	'84-'01 Phazer's	
'88 Excel V	'90 Excel V	'97-'01 Mountain Max's	'89-'90 Ovation	'92-'98 Ovation	'84-'01 Phazer's		
'92-'95 Enticer	'89 Enticer 400	'85-'91 SRV's	'96-'98 Venture 480	'85 V-max			
'85-'86 Excel V	'88 Excel V	'90 Excel V	'97-'01 Mountain Max's	'89-'90 Ovation	'92-'98 Ovation	'84-'01 Phazer's	
'88 Excel V	'90 Excel V	'97-'01 Mountain Max's	'89-'90 Ovation	'92-'98 Ovation	'84-'01 Phazer's		
'92-'95 Enticer	'89 Enticer 400	'85-'91 SRV's	'96-'98 Venture 480	'85 V-max			
'85-'86 Excel V	'88 Excel V	'90 Excel V	'97-'01 Mountain Max's	'89-'90 Ovation	'92-'98 Ovation	'84-'01 Phazer's	
'88 Excel V	'90 Excel V	'97-'01 Mountain Max's	'89-'90 Ovation	'92-'98 Ovation	'84-'01 Phazer's		
'92-'95 Enticer	'89 Enticer 400	'85-'91 SRV's	'96-'98 Venture 480	'85 V-max			
'85-'86 Excel V	'88 Excel V	'90 Excel V	'97-'01 Mountain Max's	'89-'90 Ovation	'92-'98 Ovation	'84-'01 Phazer's	
'88 Excel V	'90 Excel V	'97-'01 Mountain Max's	'89-'90 Ovation	'92-'98 Ovation	'84-'01 Phazer's		
'92-'95 Enticer	'89 Enticer 400	'85-'91 SRV's	'96-'98 Venture 480	'85 V-max			
'85-'86 Excel V	'88 Excel V	'90 Excel V	'97-'01 Mountain Max's	'89-'90 Ovation	'92-'98 Ovation	'84-'01 Phazer's	
'88 Excel V	'90 Excel V	'97-'01 Mountain Max's	'89-'90 Ovation	'92-'98 Ovation	'84-'01 Phazer's		
'92-'95 Enticer	'89 Enticer 400	'85-'91 SRV's	'96-'98 Venture 480	'85 V-max			
'85-'86 Excel V	'88 Excel V	'90 Excel V	'97-'01 Mountain Max's	'89-'90 Ovation	'92-'98 Ovation	'84-'01 Phazer's	
'88 Excel V	'90 Excel V	'97-'01 Mountain Max's	'89-'90 Ovation	'92-'98 Ovation	'84-'01 Phazer's		
'92-'95 Enticer	'89 Enticer 400	'85-'91 SRV's	'96-'98 Venture 480	'85 V-max			
'85-'86 Excel V	'88 Excel V	'90 Excel V	'97-'01 Mountain Max's	'89-'90 Ovation	'92-'98 Ovation	'84-'01 Phazer's	
'88 Excel V	'90 Excel V	'97-'01 Mountain Max's	'89-'90 Ovation	'92-'98 Ovation	'84-'01 Phazer's		
'92-'95 Enticer	'89 Enticer 400	'85-'91 SRV's	'96-'98 Venture 480	'85 V-max			
'85-'86 Excel V	'88 Excel V	'90 Excel V	'97-'01 Mountain Max's	'89-'90 Ovation	'92-'98 Ovation	'84-'01 Phazer's	
'88 Excel V	'90 Excel V	'97-'01 Mountain Max's	'89-'90 Ovation	'92-'98 Ovation	'84-'01 Phazer's		
'92-'95 Enticer	'89 Enticer 400	'85-'91 SRV's	'96-'98 Venture 480	'85 V-max			
'85-'86 Excel V	'88 Excel V	'90 Excel V	'97-'01 Mountain Max's	'89-'90 Ovation	'92-'98 Ovation	'84-'01 Phazer's	
'88 Excel V	'90 Excel V	'97-'01 Mountain Max's	'89-'90 Ovation	'92-'98 Ovation	'84-'01 Phazer's		
'92-'95 Enticer	'89 Enticer 400	'85-'91 SRV's	'96-'98 Venture 480	'85 V-max			
'85-'86 Excel V	'88 Excel V	'90 Excel V	'97-'01 Mountain Max's	'89-'90 Ovation	'92-'98 Ovation	'84-'01 Phazer's	
'88 Excel V	'90 Excel V	'97-'01 Mountain Max's	'89-'90 Ovation	'92-'98 Ovation	'84-'01 Phazer's		
'92-'95 Enticer	'89 Enticer 400	'85-'91 SRV's	'96-'98 Venture 480	'85 V-max			
'85-'86 Excel V	'88 Excel V	'90 Excel V	'97-'01 Mountain Max's	'89-'90 Ovation	'92-'98 Ovation	'84-'01 Phazer's	
'88 Excel V	'90 Excel V	'97-'01 Mountain Max's	'89-'90 Ovation	'92-'98 Ovation	'84-'01 Phazer's		
'92-'95 Enticer	'89 Enticer 400	'85-'91 SRV's	'96-'98 Venture 480	'85 V-max			
'85-'86 Excel V	'88 Excel V	'90 Excel V	'97-'01 Mountain Max's	'89-'90 Ovation	'92-'98 Ovation	'84-'01 Phazer's	
'88 Excel V	'90 Excel V	'97-'01 Mountain Max's	'89-'90 Ovation	'92-'98 Ovation	'84-'01 Phazer's		
'92-'95 Enticer	'89 Enticer 400	'85-'91 SRV's	'96-'98 Venture 480	'85 V-max			
'85-'86 Excel V	'88 Excel V	'90 Excel V	'97-'01 Mountain Max's	'89-'90 Ovation	'92-'98 Ovation	'84-'01 Phazer's	
'88 Excel V	'90 Excel V	'97-'01 Mountain Max's	'89-'90 Ovation	'92-'98 Ovation	'84-'01 Phazer's		
'92-'95 Enticer	'89 Enticer 400	'85-'91 SRV's	'96-'98 Venture 480	'85 V-max			
'85-'86 Excel V	'88 Excel V	'90 Excel V	'97-'01 Mountain Max's	'89-'90 Ovation	'92-'98 Ovation	'84-'01 Phazer's	
'88 Excel V	'90 Excel V	'97-'01 Mountain Max's	'89-'90 Ovation	'92-'98 Ovation	'84-'01 Phazer's		
'92-'95 Enticer	'89 Enticer 400	'85-'91 SRV's	'96-'98 Venture 480	'85 V-max			
'85-'86 Excel V	'88 Excel V	'90 Excel V	'97-'01 Mountain Max's	'89-'90 Ovation	'92-'98 Ovation	'84-'01 Phazer's	
'88 Excel V	'90 Excel V	'97-'01 Mountain Max's	'89-'90 Ovation	'92-'98 Ovation	'84-'01 Phazer's		
'92-'95 Enticer	'89 Enticer 400	'85-'91 SRV's	'96-'98 Venture 480	'85 V-max			
'85-'86 Excel V	'88 Excel V	'90 Excel V	'97-'01 Mountain Max's	'89-'90 Ovation	'92-'98 Ovation	'84-'01 Phazer's	
'88 Excel V	'90 Excel V	'97-'01 Mountain Max's	'89-'90 Ovation	'92-'98 Ovation	'84-'01 Phazer's		
'92-'95 Enticer	'89 Enticer 400	'85-'91 SRV's	'96-'98 Venture 480	'85 V-max			
'85-'86 Excel V	'88 Excel V	'90 Excel V	'97-'01 Mountain Max's	'89-'90 Ovation	'92-'98 Ovation	'84-'01 Phazer's	
'88 Excel V	'90 Excel V	'97-'01 Mountain Max's	'89-'90 Ovation	'92-'98 Ovation	'84-'01 Phazer's		
'92-'95 Enticer	'89 Enticer 400	'85-'91 SRV's	'96-'98 Venture 480	'85 V-max			
'85-'86 Excel V	'88 Excel V	'90 Excel V	'97-'01 Mountain Max's	'89-'90 Ovation	'92-'98 Ovation	'84-'01 Phazer's	
'88 Excel V	'90 Excel V	'97-'01 Mountain Max's	'89-'90 Ovation	'92-'98 Ovation	'84-'01 Phazer's		
'92-'95 Enticer	'89 Enticer 400	'85-'91 SRV's	'96-'98 Venture 480	'85 V-max			
'85-'86 Excel V	'88 Excel V	'90 Excel V	'97-'01 Mountain Max's	'89-'90 Ovation	'92-'98 Ovation	'84-'01 Phazer's	
'88 Excel V	'90 Excel V	'97-'01 Mountain Max's	'89-'90 Ovation	'92-'98 Ovation	'84-'01 Phazer's		
'92-'95 Enticer	'89 Enticer 400	'85-'91 SRV's	'96-'98 Venture 480	'85 V-max			
'85-'86 Excel V	'88 Excel V	'90 Excel V	'97-'01 Mountain Max's	'89-'90 Ovation	'92-'98 Ovation	'84-'01 Phazer's	
'88 Excel V	'90 Excel V	'97-'01 Mountain Max's	'89-'90 Ovation	'92-'98 Ovation	'84-'01 Phazer's		
'92-'95 Enticer	'89 Enticer 400	'85-'91 SRV's	'96-'98 Venture 480	'85 V-max			
'85-'86 Excel V	'88 Excel V	'90 Excel V	'97-'01 Mountain Max's	'89-'90 Ovation	'92-'98 Ovation	'84-'01 Phazer's	
'88 Excel V	'90 Excel V	'97-'01 Mountain Max's	'89-'90 Ovation	'92-'98 Ovation	'84-'01 Phazer's		
'92-'95 Enticer	'89 Enticer 400	'85-'91 SRV's	'96-'98 Venture 480	'85 V-max			
'85-'86 Excel V	'88 Excel V	'90 Excel V	'97-'01 Mountain Max's	'89-'90 Ovation	'92-'98 Ovation	'84-'01 Phazer's	
'88 Excel V	'90 Excel V	'97-'01 Mountain Max's	'89-'90 Ovation	'92-'98 Ovation	'84-'01 Phazer's		
'92-'95 Enticer	'89 Enticer 400	'85-'91 SRV's	'96-'98 Venture 480	'85 V-max			
'85-'86 Excel V	'88 Excel V	'90 Excel V	'97-'01 Mountain Max's	'89-'90 Ovation	'92-'98 Ovation	'84-'01 Phazer's	
'88 Excel V	'90 Excel V	'97-'01 Mountain Max's	'89-'90 Ovation	'92-'98 Ovation	'84-'01 Phazer's		
'92-'95 Enticer	'89 Enticer 400	'85-'91 SRV's	'96-'98 Venture 480	'85 V-max			
'85-'86 Excel V	'88 Excel V	'90 Excel V	'97-'01 Mountain Max's	'89-'90 Ovation	'92-'98 Ovation	'84-'01 Phazer's	
'88 Excel V	'90 Excel V	'97-'01 Mountain Max's	'89-'90 Ovation	'92-'98 Ovation	'84-'01 Phazer's		
'92-'95 Enticer	'89 Enticer 400	'85-'91 SRV's	'96-'98 Venture 480	'85 V-max			
'85-'86 Excel V	'88 Excel V	'90 Excel V	'97-'01 Mountain Max's	'89-'90 Ovation	'92-'98 Ovation	'84-'01 Phazer's	
'88 Excel V	'90 Excel V	'97-'01 Mountain Max's	'89-'90 Ovation	'92-'98 Ovation	'84-'01 Phazer's		
'92-'95 Enticer	'89 Enticer 400	'85-'91 SRV's	'96-'98 Venture 480	'85 V-max			
'85-'86 Excel V	'88 Excel V	'90 Excel V	'97-'01 Mountain Max's	'89-'90 Ovation	'92-'98 Ovation	'84-'01 Phazer's	
'88 Excel V	'90 Excel V	'97-'01 Mountain Max's	'89-'90 Ovation	'92-'98 Ovation	'84-'01 Phazer's		
'92-'95 Enticer	'89 Enticer 400	'85-'91 SRV's	'96-'98 Venture 480	'85 V-max			
'85-'86 Excel V	'88 Excel V	'90 Excel V	'97-'01 Mountain Max's	'89-'90 Ovation	'92-'98 Ovation	'84-'01 Phazer's	
'88 Excel V	'90 Excel V	'97-'01 Mountain Max's	'89-'90 Ovation	'92-'98 Ovation	'84-'01 Phazer's		
'92-'95 Enticer	'89 Enticer 400	'85-'91 SRV's	'96-'98 Venture 480	'85 V-max			
'85-'86 Excel V	'88 Excel V	'90 Excel V	'97-'01 Mountain Max's	'89-'90 Ovation	'92-'98 Ovation	'84-'01 Phazer's	
'88 Excel V	'90 Excel V	'97-'01 Mountain Max's	'89-'90 Ovation	'92-'98 Ovation	'84-'01 Phazer's		
'92-'95 Enticer	'89 Enticer 400	'85-'91 SRV's	'96-'98 Venture 480	'85 V-max			
'85-'86 Excel V	'88 Excel V	'90 Excel V	'97-'01 Mountain Max's	'89-'90 Ovation	'92-'98 Ovation	'84-'01 Phazer's	

Fitment	Sno-Stuff USA Made			Taiwan Made			Erlandson USA Made		
	Style	Part #	Price (G)	Style	Part #	Price (D)	Style	Part #	Price (D)
Arctic Cat									
'73 Clutches 5/8 X 18 N.F.	-	-	-	-	012-164-2	\$16.95			
All Hexagon-Shaft Clutches (9/16" thread size) '73-'93	(2)	725-068	\$26.83	(2)	012-164-12	\$19.95			
Comet 108C,108EXP with std bolt (3/4"-16 thread)	(3)	725-023	\$46.92						
Comet 100,101C,102C,108C	(3)	725-201	\$29.95	(2)	012-164-19	\$19.95			
Comet 108EXP w/countersunk mount-bolt '89-'94 (7/8-14 thread)	(1)	725-070	\$53.65	(1)	012-164-15	TBA	(2)	PCP-2	\$58.98
							(2)	CPE2	\$48.64
Comet '96-'99 108EXP & 4-Pro Clutch #'s	(4)	015-2246	\$49.95						
217101,107,204,207,503,504,507,600,604,607	(4)	015-2246	\$49.95						
All other # "217" clutches use this puller	(4)	C217153	\$49.15						
All "Artco" Clutches '96-'03	(2)	725-100	\$42.38	(2)	012-164-16	\$29.95	(2)	PCP-5	\$56.02
							(2)	CPE5	\$44.79
Comet '96-'97 108 EXP and 108-4 PRO clutches	(3)	725-024	\$76.44						
Polaris									
P85-P90 Clutches with 4.3" Pin length	(3)	725-201	\$29.95	(2)	012-164-19	\$19.95			
P-85-P90 & Magnum Gold Clutches	(3)	725-203	\$40.22				(2)	PCP-1	\$51.60
							(2)	CPE1	\$39.97
with 3.3" Pin length (3/4-16 threads)	(1)	725-202	\$53.65				(2)	PCP-1	\$51.60
							(2)	CPE1	\$39.97
98-99 500,600,700 USA Twins (except 1999 440 edge)	(2)	725-206	\$53.65				(2)	PCP-7	\$70.78
							(2)	CPE7	\$44.79
2000-03 US Twins, 99-03 440 XC Edge, 99-03 700/800 XCR							(2)	PCP-8	\$73.73
							(2)	CPE8	\$53.22
'99-'03 All Fuji Engines except following: (XCR700,800=PCP-8) (340 Dlx=PCP-1)(500 Carb classic=PCP-1)(600 Triumph= PCP-1)							(2)	PCP-9	\$73.73
							(2)	CPE9	\$53.22
'93 Mach Z 780, F1 Comet OEM 40mm PTO	(3)	725-204	\$49.49						
Ski-Doo									
Metric puller used on Citations & Mirages	(1)	725-401	\$33.52						
Replacement pin for above; # 725-401		725-411	\$21.46						
Standard clutch puller (square shaft style) (5/8"-18 thread)	(2)	725-402	\$40.22	(2)	012-164-7	\$16.95			
Ski-Doo TRA Clutch '86-'87(16mm X 1 mm thread)	(2)	725-412	\$46.92						
Ski-Doo TRA Clutch (14mm X 1 mm thread) oem#529.0079.00	(2)	725-413	\$46.92	(2)	012-164-13	\$18.95	(2)	PCP-4	\$51.60
'86 Formula Plus • '87 Escapade, Formula MX, Plus, Statos • '88 Escapade, Formula MX, Plus, Stratos • '89 Alpine II, '88 Escapade, Formula MX, Plus, Stratos • '89 Alpine II, Formula 500,MX, Plus, Safari Cheyenne, Escapade, Voyageur, '90 Alpine II, Formula 500, MX, Plus, Mach-1 583, Safari Cheyenne, Scout, Safari L,LC,LE,LX,LE,GLX • '91 Alpine II,Formula MX, Plus, Mach-1 617, Safari Cheyenne, Scout L,LE,LCE,LXE,GLX • '92 Formula MX, Plus, Plus-X, Safari L,LE,LCE,GLX, Skandic II,Tundra • '93-'97 All Formula's (except 670's) Grand Tour.583, Safaria, Skandic II, Summit 500,583, Tundra's • '95-'97 MX-Z 440,500,583							(2)	CPE4	\$00
Ski-Doo TRA '93-'97 Mach 1 670 • oem# 529.0224.00	(2)	725-414	\$29.95	(2)	012-164-18	\$19.95	(2)	PCP-3	\$51.60
'94-'99 Gr-Tour SE670 • '95-'99 Formula SS '96-'97 MX-Z 670 • '95-'99 Formula III 600,700 • '95-'99 Summit 670 • '98 CK-3 Chassis Mach Z (800)'98 CK-3 Chassis Mach Z (800)							(2)	CPE3	\$39.97
Yamaha									
'74-'75 GPX, '76 STX 340/440, '79 ET 300, '76 EX340/440 (5/8"x18 thread)	(2)	725-601	\$40.22						
(20mm X1.5 threads) '81-'88 EC 340, '76-'80 SRX,'78-'88 ET 340, '77-'78 EX 340,'77-'79 EX 440,'80EC540	(3)			(2)	012-164-14	\$19.95			
YPZ & YXR Clutches 85-86 Phazer, 85-86 SRV, 85 SS440, 92-93 V-Max 4, 85-86 Excel-V, 97-04 V-Max 500, 600, 700 (18mm x 1.5 thread)	(3)	725-603	\$29.95				(2)	PCP-6	\$51.60
Comet, V-Max 1983 (16mm x 1.5 threads)	(3)	725-604	\$33.52				(2)	CPE6	\$37.80
79-ET300 • 81-84 ET250,300 • 82 SRV • 82-86 Bravo's • 84-96 Phazer's • 76 STX340,440 • 74-75 GPX338,433 • 92-96 V-max 4's • 95-96 V-max 500-600's				(2)	012-164-10	\$18.95			
Miscellaneous Pullers									
Rupp Clutches				(2)	015-870	\$16.95			
Early Quikshift & 72 EXT Round shaft clutch (7/8"-9 thread)	(2)	725-011	\$46.92						
Quikshift '85 and older models (9/16"-18 thread)	(2)	725-012	\$30.19						
Comet 94C Duster clutches (9/16-18 thread size)	(2)	725-021	\$40.22						
Polaris, Powerbloc-Brut (1/2" external threads)	(2)	725-031	\$40.22	(2)	015-872	\$16.95			
Powerbloc (9/16"-18 external threads)	(2)	725-032	\$40.22						
Kawasaki w/hex clutch '78 Intriguer 440, Inviter 340 '79-'80 Drifter 340, 440	(2)	725-068	\$26.83	(2)	012-164-12	\$19.95			
Kawasaki made clutches (18mm) '78-'82 Intruder/Invader/LTD	(4)	725-501	\$29.95	(2)	012-164-9	\$16.95			

Style # 1



Style # 3



Style # 2



Style # 4



Drive Clutch Compressor Tool

Compresses drive clutches for easy cam arm changes.



725-183

**725-283
003-448
P2871173**

Description	Part #	Price (F)
Artco Drive Clutch Compressor Tool	725-183	\$26.76
	003-448	\$29.95
Polaris & Comet Drive Clutch Compressor Tool	725-283	\$26.76
Genuine Polaris drive clutch compressor tool	P2871173	\$65.95
Yamaha	725-683	\$26.76

**Clutch Spider Tool
by Sno-Stuff**

- Fits Artco Clutches

Description	Part #	Price (F)
Clutch Spider Tool	725-185	\$93.81



Clutch Spider Tools

Description	Part #	Price (D)
Spider Nut Tool fits; Polaris Spider lock nut	725-286	\$53.95
Spider Tool fits; all Polaris Clutches	28-341	\$54.95
Spider Nut Tool fits; Artco Clutch Spider nut	725-186	\$33.46



**Clutch Tools
for P85 & P90 clutches**

Clutch Holding tool fits all Polaris snowmobile & ATV clutches. A must for all clutch rebuilders.



Description	Part #	Price (D)
Polaris	725-280	\$81.81

**Arctic Cat Clutch Holding Tool
by Sno-Stuff**

Bolts down to your work bench for easy disassembly and assembly.

- 33mm fits Artco Clutches
- 30mm fits Comet 102 & 108's



Description	Part #	Price (D)
Arctic 30mm Hold Down tool	725-180	\$53.59
Arctic 33mm Hold Down tool	725-181	\$53.59

**Clutch Tools
for Polaris & Artco clutches**

Clutch Holding tool fits all Polaris & Artco snowmobile & ATV clutches. A must for all clutch rebuilders.

Description	Part #	Price (D)
Artco clutches	STA20-192	\$99.95
Polaris	STA20-162	\$94.95



Clutch Sheave Holding Tool

- Holds clutch together when changing weights without removing cover.



Description	Part #	Price (G)
Clutch Sheave Tool	20-86	\$9.95

TRA Retainer Clip Set

When installing TRA buttons this tool holds all 6 buttons in place while assembling clutch. A must for all shops. Comes in a set of 3

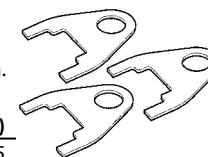

Description	Part #	Price (D)
TRA Retaining clip set	28-505	\$26.95

Weight Bushing Replacing Tool



Description	Part #	Price (G)
Weight Bushing Tool	15-500	\$14.95

**Spider Roller Tool
for Polaris clutches**



Description	Part #	Price (F)
Roller Tool	725-287	\$14.95

Spider Aligning Tool for Polaris

- The simplest tool for removing pin and rollers from Polaris spiders. Aligns all parts perfectly.



Description	Part #	Price (G)
Spider Aligning Tool	STA20-85	\$34.24

SLP Button Tool for Polaris Drive Clutches

Remove spider buttons quickly and easily without damage with this new tool from SLP. Tool uses a precision collet to lock around the outside of the button. It's ergonomical pistol grip shape allows you to lock onto the button, remove it, and release it with ease.



Description	Part #	Price (D)
SLP Button Tool	STA20-180	\$26.95

Button Removal Tool for Polaris

- The only proper way to remove polaris spider buttons

Description	Part #	Price (E)
Button Removal Tool	STA20-77	\$50.66
Button Removal Tool	725-288	\$26.76
(imported)	SM-12187	\$24.95



725-288

STA20-77

Clutch & Flywheel Holding Tools

An excellent tool for every shop. Ideal for holding the Clutch when removing and installing.

Description	Part #	Price (F)
TRA Clutch Holder	28-500	\$22.95
Polaris/ A-Cat Clutch Holder	28-501	\$22.95
Polaris Flywheel Holder	28-509	\$22.95

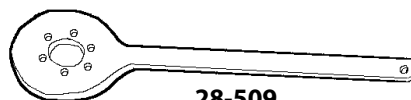

28-509

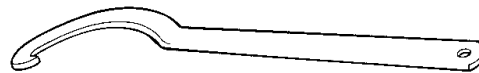

28-500

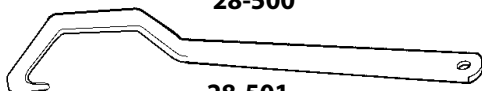

28-501

Clutch Offset Aligning Tools

Description	Part #	Price (F)
Polaris Offset Tool P-85 clutches 1980-2001	28-498	\$22.95
Offset Tool A-Cat w/Artco Primary ,Comet Secondary	28-497	\$22.95
Offset Tool A-Cat w/Comet Drive ,Comet Secondary	28-499	\$22.95
Offset Tool Ski-Doo F2000,S2000 (toolbox size)	28-502	\$14.95
Offset Tool Ski-Doo CK-3 Chassis (toolbox size)	28-503	\$14.95
Offset Tool Ski-Doo F2000,S2000	28-506	\$22.95
Offset Tool Ski-Doo CK-3 Chassis	28-507	\$22.95
Offset Tool Ski-Doo Rev Chassis	28-508	\$22.95
Yamaha Offset Tool 97-up YPZ-clutches	28-496	\$22.95

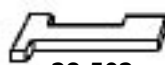

28-502

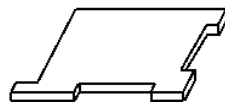

28-503

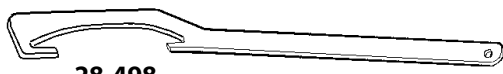

28-498



28-506

28-507

28-508



28-497



28-499



Engine Location Tool

A must for every high performance shop. Save time and shop labour using this new Engine Location Tool.

Model	Part #	Price (D)
Yamaha	28-366	\$39.95



Secondary Puller for Polaris

Genuine Polaris secondary clutch puller for use on 750 Storm (1993).

Description	Part #	Price (D)
Secondary Puller	SCP-1	\$34.62



Clutch Service Tool

Introducing a revolutionary new tool for servicing Polaris or Comet drive and driven clutches. For drive clutches the SLP tool will compress the spring for easy cam arm changes, or cover bolt removal. For driven clutch service, the SLP tool will compress the helix and hold it in place for snap ring installation. Wrestling with the clutches or needing a friend to help is now history with this amazing tool. A great time saver for every racer and mechanic.

Description	Part #	Price (E)
Polaris Clutch service tool	STA20-99	\$129.15
Skidoo Clutch service tool (non RER)	*STA20-128	\$119.95
Arctic Cat 97 ZR style tool	STA20-130	\$80.00
Arctic Cat & Yamaha	STA20-134	\$119.95
Replacement buttons for above	STA20-131	\$1.50

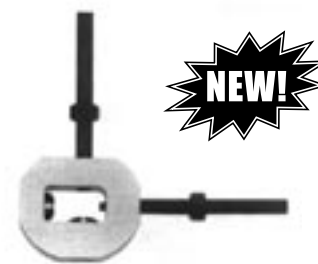

MTX Rivet Set and Removal Tool

Allows you to fine tune your MTX weights quickly and easily by setting or removing rivets. Specifically designed to be used in the field (but can be clamped for shop use). Also sets and removes Yamaha Clutch weight rivets.

Description	Part #	Price (E)
MTX Rivet Tool	STA20-155	\$74.95



Finger Adaptors

For 20-99 & 20-128 Clutch tools. Change springs in your Rapid Reaction (Team performance) Driven clutches. Built from non stick rubber to provide maximum control. Sold per pair.

Description	Part #	Price (E)
Rapid Reaction Finger Kit	STA20-171	\$19.95

Driven Clutch Puller for Arctic Cat by Sno-Stuff

A universal design that will work on all 1981 and newer reverse cam secondary clutches with button or roller covers.



Description	Part #	Price (D)
Driven Clutch Puller	725-182	\$66.98

Bench Mount Clutch Compression Tool for Diamond Drive Clutch

Designed specifically for the Diamond Drive clutch found on many late model Arctic Cats. This tool makes assembly and disassembly of this complex clutch a breeze. Comes complete with a TSS clutch Tool (Part # STA20-166). Also supplied with a number of adapters that allow it to work with most other driven clutches including Team Rapid Reaction, Arctic Cat 1992 and newer, and Polaris button clutches.



Description	Part #	Price (D)
Diamond Drive	STA20-167	\$269.95

Multi-Purpose Clutch Tool for Arctic Cat with Diamond Drive



Multi-purpose tool that allows effortless belt changes, belt deflection adjustments and driven spring tension adjustments. Designed to work in conjunction with the BD Belt Deflection Adjuster (Part #STA20-157 or Part #STA20-158) and the BD Spring Tool (Part #STA20-159).



Description	Part #	Price (D)
Diamond Drive	STA20-166	\$44.95

Belt Deflection Adjuster for Arctic Cat with Diamond Drive

Insure proper belt deflection is maintained with this strong aluminium belt deflector adjuster.



Description	Part #	Price (D)
2004-2005 ZR 900, 2005 Firecat, 2004 T660 (Right hand thread)	STA20-157	\$22.95
2005 M-Series, T660 (Left Hand Thread)	STA20-158	\$22.95

Spring Tool for Arctic Cat with Diamond Drive



Easily fine tune your clutching by changing the driven clutch spring tension with the use of this handy tool.



Description	Part #	Price (D)
Diamond Drive	STA20-159	\$24.95

Diamond Drive Track Socket and Nut

This socket is required to remove track, brake or driveshaft from the sled. The nut is a locking nut that needs to be replaced if removed.



Description	Part #	Price (D)
Track Socket	STA20-168	\$45.95
Brake Retainer Nut	STA20-169	\$8.95

Diamond Driven Adjustment Tool for Arctic Cat

Description	Part #	Price (F)
Driven Adjust Tool	RSR28-510	\$37.95



Tension Adjustment Scale

Finally an easy method of measuring and setting tension. This new scale has a range 0-25 lbs. It is very accurate and has a "tattle tale" marker to help measure more precisely. Works excellent for secondary clutch breakout tension, track tension, water pump belt deflection. etc.



Description	Part #	Price (D)
Tension Adjustment Scale	STA20-182	\$41.95



Spring Compression Tool

For RER Skidoo Driven Pulleys. Change helix or springs easily and safely with this SLP spring compression tool. Designed to be used in a vise or mounted to a bench.

Description	Part #	Price (E)
Spring Compression Tool	STA20-143	\$79.95



Clutch Compression Tool

Allows one person to compress clutches for service work, remove and install helixes, change springs and maintenance.

- Snowmobile** Polaris, Arctic Cat, Yamaha, and Comet Primary clutches. Skidoo RER Driven Pulleys
- ATV** Yamaha, Arctic Cat, Suzuki Secondary clutches Polaris, Kawasaki, and Comet Primary clutches Kawasaki 360 & 650 Prairie Secondary clutches

Description	Part #	Price (F)
Clutch Compression Tool	CCT500	\$118.04

Clutch Spring Compressor

Uninstall and remove primary springs safely on your TRA primary clutches. Mounts to vise or can be drilled and mounted to your bench.



Part #	Price (F)
CCT700	\$78.98

Spring Installation Tool

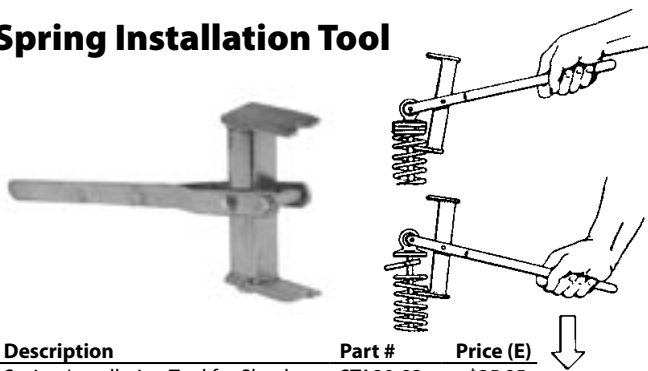

Description	Part #	Price (E)
Spring Installation Tool for Shocks	STA20-83	\$35.95

Shock Spring Installation Tool

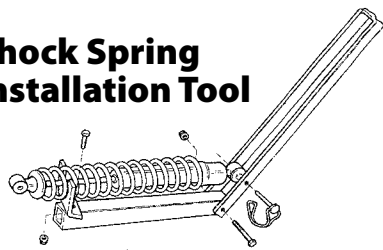

Description	Part #	Price (C)
Spring Installation Tool	RSR28-121	\$54.95

Shock Spring Adjusting Tool



Description	Part #	Price (D)
Shock Spring Adjusting Tool	004-1279	\$10.95

Spring Adjustment Tool



Description	Part #	Price (G)
Spring Adjustment Tool	SM-08003	\$15.95



Snap Ring Pliers

- External & Internal

Description	Part #	Price (D)
Snap Ring Pliers	15-856	\$7.95

Track Clip Tool Kit

Sno-Stuff has taken their existing track clip tools and inserted them in a great carrying case. Fits both wide and narrow track clips.

Description	Part #	Price (D)
Track clip tool kit	725-005	\$107.24
Parts		
Guide bolts	725-000-201	\$5.50
Centre screws	725-000-405	\$22.31
Wide insert	725-000-407	\$39.95

Track Clip Pliers

Description	Part #	Price (G)
wide clips (1.5")	004-149-12	\$79.95
narrow clips (1")	004-149-13	\$129.95

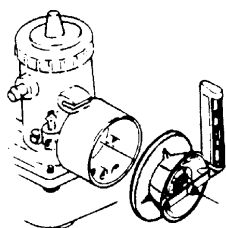

Uni-sync Carb Synchronizer

Description	Part #	Price (A)
Uni-sync Carb Synchronizer	014-139	\$54.07

Piston Pin Puller

Description	Part #	Price (D)
Piston Pin Puller	012-610	\$21.95

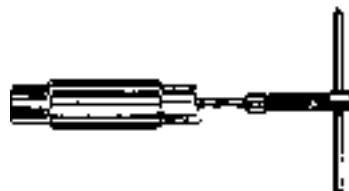

Carb Leak Detector



Description	Part #	Price (D)
Carb Leak Detector	007-400	\$55.95

Polaris Flywheel Puller

Comes w/high quality grade 10.9 bolts.

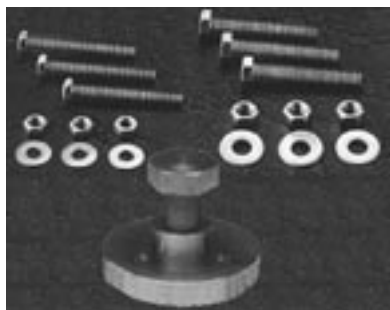

Description	Part #	Price (E)
Polaris Flywheel Puller	STA20-135	\$55.95

Universal Flywheel Puller

Comes w/high quality 6mm & 8mm bolts



Description	Part #	Price (E)
Universal Flywheel Puller	009-620	\$39.95

Maximum Flywheel Puller for Polaris

Snowmobiles, Watercraft, ATV. Comes w/ high quality grade 10 bolts, 6mm and 8mm

Description	Part #	Price (E)
Flywheel Puller	STA20-142	\$132.95



Exhaust Spring Removal Tools

Description	Part #	Price (E)
Exhaust Spring Tool	725-900	\$19.46
4" Size	STA20-89	\$14.83
6" Size	STA20-90	\$15.50

Description	Part #	Price (F)
Exhaust Spring Tool	M/P08-065	\$12.95



Extension Spring Tool

An excellent tool for every shop. Ideal for removing exhaust springs.



Description	Part #	Price (D)
Extension Spring Tool	STA20-133	\$42.95

Flywheel Puller Universal

Comes w/high quality 6mm & 8mm bolts

Description	Part #	Price (F)
Flywheel Puller	725-010	\$40.22



Timing Light

Superb timing light for 2 cycle engines. performs at high RPM where many automotive lights do not. Battery operated two "D" size batteries.

Description	Part #	Price (E)
Timing light	STA20-127	\$145.72

Digital Caliper



Description	Part #	Price (G)
Digital Caliper	SM-12036	\$114.29

Compression Tester (small)

Only 7½" long this great little high quality compression tester has the snowmobiler in mind. Comes with both 14 mm & 18 mm thread sizes. A great item for any Snowmobile, ATV, or Watercraft Shop.



Description	Part #	Price (A)
7½" Long Compression Tester	STA20-149	\$37.95

Dial Indicator Tool



Description	Part #	Price (A)
Dial Indicator	STA20-92	\$78.95

Degree Wheel



Description	Part #	Price (E)
Degree Wheel	STA20-91	\$22.95

Piston Light

This flexible Bend-A-Light is a must for all snowmobile tuners. With a high intensity bulb it is perfectly suited for reading your piston wash. Also works great for lighting hard to see areas when wrenching on your sled, atv, or watercraft.

Bend-A-Light®
"The Industry Leader"
Made in the U.S.A.

10150A 16" Bend-A-Light Pro

- High intensity flexible light bends and holds any position
- Amazing brightness for tight situations, 3/16" Diameter Bulb
- 10" Flexible brass alloy shaft
- Protective cover can also be used as an extension
- 2 AA alkaline batteries (included)

10250A 16" Micro-Pro Bend-A-Light

- High intensity flexible light bends and holds any position
- Ultra small bulb head, 1/8" Diameter
- 10" Flexible brass alloy shaft
- Protective cover can also be used as an extension
- 2 AA alkaline batteries (included)

16102 11" Mini-Pro Bend-A-Light

- High intensity flexible light bends and holds any position
- Amazing brightness for tight situations, 3/16" Diameter Bulb
- 5" Flexible brass alloy shaft
- Pocket clip acts as switch
- 2 AAA alkaline batteries (included)

10355A & 10359A 16" Bend-A-Light Pro Kit in Tray

Both Kits Include:

- 10150A Bend-A-Light Pro
- 10" Brass shaft
- Plastic handle
- Protective cover
- 2 AA alkaline batteries

12300 Illuminating pick-up magnet
12300 Hands free magnet
12500 Pocket flashlight
12600 Extension mirror (only fits #12500)
(Kit 10359A comes in a vinyl carrying pouch)

15150A 24" Krypton Pro Bend-A-Light

- High intensity flexible light bends and holds any position
- Ultra bright Krypton bulb, 3/16" diameter
- 15" Flexible brass alloy shaft
- Protective cover can also be used as an extension
- 2 AA alkaline batteries (included)

Bend-A-Light

Description	Part #	Price (F)
Bend-A-Light 16"	10150A	\$44.47
Bend-A-Light 16" Micro-Pro	10250A	\$53.36
Bend-A-Light 11" Mini-Pro	16102	\$35.56
Bend-A-Light Kit 16"	10355A	\$67.95
Bend-A-Light Kit 16" w/pouch	10359A	\$71.15
Bend-A-Light 24" Krypton-Pro	15150A	\$80.07

Bend-A-Light Specifications

Model#	Flex-Shaft Length	Overall Length	Batteries	Handle	Shaft	Lamp#	Lamp Price	Lamp Diameter	Replacement Switch	Switch Price
16102	5"	11"	2-AAA	Plastic	Brass	12100	\$14.95	3/16"	-	-
10150A	10"	16"	2-AA	Plastic	Brass	12100	\$14.95	3/16"	12777	\$8.95
10250A	10"	16"	2-AA	Plastic	Brass	12120	\$16.95	1/8"	12777	\$8.95
15150A	15"	24"	2-AA	Plastic	Brass	12100	\$14.95	3/16"	12777	\$8.95

TPS (Throttle Position Sensor) Tester

Test and adjust your TPS setting quickly and accurately with this special tool. TPS tester kit includes wiring harness to connect to most Arctic Cat and Polaris models, as well as a special TPS Screwdriver and detail instructions. Arctic Cat F5, F6, F7 & M-Series chassis require the optional wiring pigtail.



Description	Part #	Price (E)
Throttle Position Tester Kit	STA20-193	\$179.95
Wiring pigtail adaptor F & M A-Cats	STA20-194	\$89.95
Replacement TPS Screwdriver	STA20-195	\$20.95

Rec-Lift Snowmobile & ATV



*Freight not included

- Lifts your sled 2 feet off the ground.
- Prevents damage to suspension due to sag from sitting over the summer.
- You no longer have to work on your sled laying on the wet cold floor.
- Save your back while servicing the engine and clutches.
- A Must for all Snowmobile Shops.
- **Rec-Lift** is compact and portable.
- When not in use it can easily be stored against the wall or under a bench.

Description	Part #	Price* (A)
Rec-Lift	599-101	\$329.95



Description	Part #	Price
Jack Roller	068501	\$169.95

Big Wheel Shop Dolly



Description	Part #	Price* (D)
Shop Dolly - Polymer Wheels	710-207	\$279.94
Shop Dolly - Aluminum Wheels	710-208	\$337.94

*Freight not included

Shop Dolly

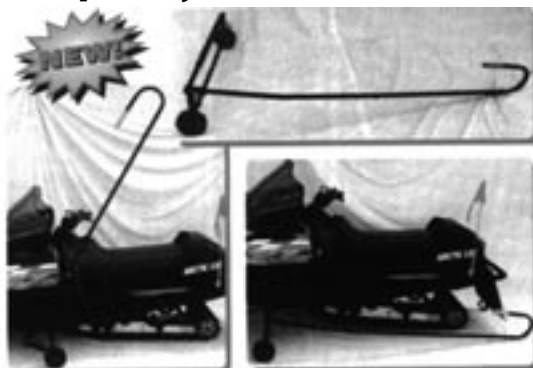

Description	Part #	Price* (A)
Shop Dolly	710-220	\$159.95

SNO-WHEELS™ Now comes with new Steal/Rubber castors!



SNO14-106



SM-12220



SNO14-105

SNO14-104

Description	Part #	Price (G)
Sno-Wheels Stealth 360 (kit)	SNO14-104	\$59.95
Sno-Wheels Stealth II (plastic base kit)	SNO14-105	\$52.22
Sno-Wheels-UFO (kit)	SNO14-106	\$65.56
Sled Dolly (set)	SM-12220	\$84.95

Track Jack

- Heavy duty steel with black powder coating.
- Fits all Polaris models including RMK

Description	Part #	Price (D)
Track-Jack	SM-12271	\$64.95
Max Height = 30"	SM-12274	\$129.95
Max Height = 38"	SM-12274-1	\$109.95



SM-12274
SM-12274-1



SM-12271

*Freight not included



Torco Snowmobile Oil

Description	Part #	Price (D)
Synth/Petro Snow Oil .946 L (12/cs.)	TOR1L	\$7.25
Synth/Petro Snow Oil 3.784 L (6/cs.)	TOR4L	\$25.99
100% Synthetic Racing Oil 3.784 L (6/cs.)	TOR4LS	\$40.99
100% Synthetic Racing Oil .946 L (12/cs.)	TOR1LS	\$10.99
Chain case 100 Synthetic Oil .473 L (24/cs.)	TOR473	\$10.25
Shock Fluid	TOR1SSF	\$14.50



LiquidVac

Quickly and easily remove old oil or anti-freeze without the mess. Simply insert the suction hose into the dipstick tube or coolant bottle, then apply a vacuum to the LiquidVac tank with several strokes of the high volume hand pump. The LiquidVac's powerful vacuum action quickly draws the old fluid into its big 2 gallon capacity tank.

Description	Part #	Price
LiquidVac	STA20-148	\$75.95



XRC & RPM 2-Cycle Oil

For Injector or Premix Applications

A High quality 2-Cycle lubricant specially formulated to meet the exacting requirements of the snowmobile engines today. This oil is the highest quality, ashless engine oil with performance additives.

Description	Part #	Price (G)
1-Litre container (12/case)	XRC1L	\$4.95 ea.
4-Litre container (4/case)	XRC4L	\$15.95 ea.
Chain case oil 350 mL (12/case)	RPM350ML	\$3.50

Fuel Stabilizer

Protect your investment from that long summer sit. Stabilizes fuel so you don't have to clean those carbs out in the fall.



Description	Part#	Price (D)
Fuel Stabilizer	59601	\$5.95

Isoflex PTO Bearing Grease



Description	Part#	Price (net)
Isoflex Bearing Grease	NB-52	\$5.95



Accu-Mix measuring bottle

Part #	Price (D)
AAA700619	\$5.95



VP Racing C-5 Octane Booster

New larger 560 mL bottle V/P Racing fuels available, call for pricing.

Description	Part #	Price (net)
C-5 Octane Booster	V/PC5	\$18.95

Ratio-Rite

Getting the right oil-to-gas ratio is no problem with this polypropylene measuring cup. Ratios from 16:1 to 50:1. 18 oz. capacity.



Description	Part#	Price (F)
Ratio-Rite	HPE959-001	\$10.95

Wynn's Engine Fogging Oil

Protect your investment with the off season fogging oil from Wynn's comes in a 35 g Aerosol Spray can.

Description	Part #	Price (D)
Wynn's Engine Fogging Oil	AAA736926	\$8.75



Isopropyl (Gas Line Antifreeze)

Description	Part #	Price (F)
150 mL Isopropyl 40/Case	071-150	\$1.50 ea.
350 mL Isopropyl 12/Case	071-350	\$2.45 ea.





Time saving products that work are a must for every shop!

Description	Part #	Price (F)
A. Brake Cleaner. This highly concentrated solvent blend provides maximum performance without ozone depleters or chlorinated solvents. A must for cleaning clutches!! 20 oz. spray.	890-9107	\$7.95
B. Rost Off. Penetrating oil loosens rusty bolts, eliminates squeaks protects against rust and salt corrosion 300ml. Spray can.	890-2	\$10.95
C. HHS2000 High pressure, resistant Synthetic Lubricant. Works best where parts should normally be dismantled for lubrication. 500 mL spray.	893-106	\$19.95
D. Dry Graphite spray provides a long lasting film on parts for extended service. 312 gram spray .	893-555	\$15.95
E. Plastic Repair Kit Repair of flexible plastics such as Polyurethane, Thermoset Polyurethane.	890-9003	\$47.95

Description	Part #	Price (G)
Silicone Liquid Gasket (-60 to +250C) Forms a rubberized seal to prevent Gas, Water & Oil leaks	TB1211	\$20.95 ea.
Liquid Gasket An excellent Crankcase Sealer for all engines	TB1104	\$6.95 ea.
Hi-Temperature Thread-Lock	TB1360	\$4.50 ea.
Engine Gloss; for the detail conscious owner who wants their engine to shine.	TB6501	\$8.95 ea.
Super Glue; Excellent for non-porous materials. Dries in seconds	TB1742B	\$2.50 ea.
Plastic Repair Kit; Great for repairs on plastic body parts.	TB1743	\$59.95 per kit
Clear Silicone universal	TB1212C	\$17.95 ea.



Description	Size	Part #	Price (D)
Thread Locker Red	6 mL	LOC26200	\$7.95 /tube
Thread Locker Blue	6 mL	LOC24200	\$9.30 /tube
Form-A-Gasket #2 Sealant Tacky, flexible-setting sealant is designed for flexible materials and flanges. Temp. range -65°F to 400°F	80 mL	LOC2BR	\$4.95 /tube
Spray-A-Gasket (High tack)	113 g	LOC99GA	\$6.50 /can
Gasket Remover Quick removal of old gasket, silicone, grease and paint without damaging your cylinder or manifolds	340 g	LOC4MA	\$8.95 /can
Form -A-Gasket (brush on type)	118 mL	LOC471H	\$6.50 /can
Cold Weld Bonding Compound • Withstands heat to 300°F • Drill it, Tap it, File it, Machine it • Thousands of uses	56 g	LOC14600	\$7.90 /tube x 2
Aviation Form -A-Gasket	473 mL	LOC3D	\$11.50 /can
Ultra Copper High Temp RTV Silicone • The most advanced hi-performance, high temperature RTV gasket available. • Temperatures up to 700° F	85 g	LOC101BR	\$10.73 /tube
Ultra Black OEM Hi-temp RTV Silicone •OEM tested to comply with Extended Warranty requirements. Sensor safe •Excellent Adhesion •Non-Corrosive	95 g	LOC598	\$9.95 /tube



Multi-Knives

Description	Part #	Price (G)
Folding Multi-Knife with Pliers	SM-12228	\$19.95
Pocket Multi-Knife	SM-12231	\$9.95



SM-12228



SM-12231

Impact Screwdriver



Description	Part #	Price (G)
Impact Screwdriver	012-2850	\$19.95

Econokit Metric Tool Kits

- Convenient and easy-to-carry tool kits
- Includes one adjustable wrench, two combination wrenches, hex keys, spark plug socket, 6-in-1 reversible screwdriver, tire gauge, WD-40®, zip ties, shop rag, and yes, even bailing wire
- Comes in heavyweight nylon shell with YKK zippers
- Closed dimensions: 4" L x 9" W x 1½" thick

Description	Part #	Price (D)
Econokit Metric Tool Kit	632100	\$39.95



632100

Econokit Snowmobile Tool Kit

- With this kit, you can tackle problems with your own sled — or almost anyone else's
- Designed for the most common fasteners used on Arctic Cat, Polaris, Ski-Doo and Yamaha sleds
- Contains five combination 10mm, 12mm, 14mm, 1/2" and 9/16" wrenches; and 8" adjustable wrench; 2 hex keys (3/16", 2.50mm) and two Torx® keys (T-20, T-25); a locking pliers; a 13/16" sparkplug socket; and a 6-in-1 reversible screwdriver
- It all goes into a 600 denier Cordura® zippered pouch, which also contains cable ties, mechanic's wire and a shop towel

Description	Part #	Price (D)
Econokit Snowmobile Tool Kit	632102	\$55.95



632102

Fanny Pack Tool Kit

- So complete, you're ready to ride
- Includes wrenches, pliers, hex keys, screwdriver, packWrench™, flashlight, tire levers, tire gauge and more
- Top quality hardware and straps
- Pouch designed to handle heavy trail abuse using 5040 nylon with plenty of extra storage

Description	Part #	Price (D)
Fanny Pack Tool Kit	632101	\$89.95



632101

Econokit Tool Kit

- A general-use kit for a wide variety of non-metric vehicles
- Includes 3/8", 7/16", 1/2" and 9/16" combination wrenches, 8" adjustable wrench, 6-in-1 screwdriver, locking pliers, tire pressure gauge, electrical tape, cable ties, mechanic's wire, thread locker, WD-40®, and shop towel
- Packaged in a coated polyester zip-up

Description	Part #	Price (D)
Econokit Generic Tool Kit	631109	\$49.95



632109

Tool Kits

- Convenient and easy-to-carry tool kits
- Available in standard or deluxe versions
- Deluxe version includes 3/8", 7/16", 1/2", 9/16" and 10mm combination wrenches, 8" adjustable wrench, five hex keys, three TorxR keys, a 6-in-1 reversible screwdriver, 5/8" and 13/16" spark plug sockets, gap gauge, thread locker and a two-AA battery metal-body flashlight with adjustable beam and a spare bulb
- Standard version includes 3/8", 7/16", 1/2", 9/16" and 10mm combination wrenches, five hex keys, three Torx® keys, a 6-in-1 reversible screwdriver, a 2-in-1 sparkplug tool with 5/8" and 13/16" sizes (includes breaker bar), cable ties, mechanics wire, a tire pressure gauge and a shop towel
- Kits come in a coated polyester roll-up style blue pouch

Description	Part #	Price (D)
Econokit Deluxe Tool Kit	631107	\$72.95
Econokit Standard Tool Kit	631108	\$49.95



632108



632107

Clymer Manuals

Clymer and Intertec repair manuals offer complete repair information and are designed for both do-it-yourselfers and professional mechanics. Readers learn the skills that let them save money on maintenance and repair bills and enjoy the satisfaction of working on their own snowmobile.



Every Clymer manual features detailed illustrations and photographs that guide the reader through each job. These titles include information covering troubleshooting, lubrication, maintenance and tune-up, engine overhaul procedures, primary and secondary clutch fundamentals and service, fuel systems, exhaust and emission control systems, electrical systems, front suspension steering, rear suspension and track, brake service and more. Complete wiring diagrams for all models are included.

Description	Part #	Price (F)
11th Ed. Service Manual -covers 97 manufacturers and is the only universal repair and maintenance source available for snowmobiles produced through 1986.	SMS11	\$41.95
Vintage Snowmobiles Vol.1-Arctic Cat '74-'79, John Deere '72-'77, Kawasaki '76-'80	S820	\$41.95
Vintage Snowmobiles Vol.2 -Polaris '73-'79, Ski-Doo '70-'79, Yamaha '75-'80	S821	\$41.95
Arctic Cat; El-Tigre EXT '88-'89, Wildcat '89	S835	\$41.95
Arctic Cat; '90-'98 Cougar, El Tigre, EXT, Panther, Panther, Powder Extreme, Powder Special, Powder Special EFI, Prowler, Prowler Mountain Cat, Z, ZL, ZR, ZRT	S836	\$41.95
Polaris Indy's '84-'89	S832	\$41.95
Polaris Indy's '90-'95	S833	\$41.95
Ski-Doo; Formula MX '85-'89, Formula Plus '85-'89, Mach 1 '89	S829	\$41.95
Ski-Doo; Formula MX, Plus, Mach-1 '90-'95	S830	\$41.95
Yamaha; EX 570 '87-'89, Phazer '84-'89	S826	\$41.95
Yamaha; Three-Cylinder Models '97-'02 MM600, SX600, VT600, VX600ER, VX600SX, MM700, SX700, VT700, VX700SX, VX700SXS, VX700XT, VX700XTC, VX700XTCD, VX700TCP.	S827	\$41.95

Carb Tuning Handbook

A completely new and updated Carb Tuning Handbook. This book covers the basics in carb tuning, testing and racing. Mikuni's Roundslide, Flatslide, and new TMX are discussed in detail. A must for the serious rider who wants the most out of their sled. Learn how to diagnose your carb's performance, use correct testing procedures, and calibrate with the proper tools.

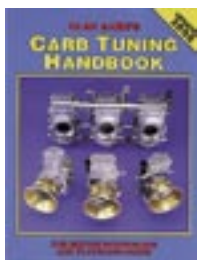

Title	Part #	Price (D)
Carb Tuning Handbook	021-102	\$39.95

Clutch Tuning Handbook

An absolute must for any clutch mechanic. This handy handbook by Olav Aaen includes theory and modification of the Comet, Arctic, Polaris, Skidoo & Yamaha. This handbook is geared to the serious racer or anyone who wants more performance from their snowmobile clutch.

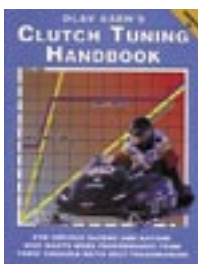

Title	Part #	Price (D)
Clutch Tuning Handbook	021-101	\$34.95

"As the Snow Flies"

This Publication provides the first recorded complete history of early snowmobile development in both Canada and the United States. The time frame is from 1900 to 1960 which is the period pioneering work was done. Small recreational and utility snowmobiles, large track driven snowmobiles, as well as propeller driven snow vehicles are covered. There is a separate chapter for each company or person who produced snowmobiles on a commercial basis during the specified time period. Each chapter includes coverage of the trials and tribulations of the inventors, as well as specifications of the models being developed. Sales brochures and copies of patents are included when available. A bibliography is included at the end of each chapter. The last two chapters provide an engineering and performance analysis of the various designs, as well as a chronological history of the important events in snowmobile development.



Title	Part #	Price (F)
As the Snow Flies	119200	\$94.95