

Tools and Maintenance

04

section contents

<i>Books and Manuals</i>	96	<i>Isopropyl Gas Line Antifreeze</i>	93
<i>Carb Synchronizer</i>	89	<i>Mixing and Measuring Bottles</i>	94
<i>Carburetor Leak Detector</i>	89	<i>Octane Booster</i>	93
<i>Clutch Pullers</i>	82	<i>Piston Light</i>	91
<i>Clutch Tools</i>	86	<i>Piston Pin Puller</i>	89
<i>Compression Tester</i>	90	<i>Shock Spring Tools</i>	89
<i>Degree Wheel</i>	90	<i>Snap Ring Pliers</i>	89
<i>Dial Indicator Tool</i>	90	<i>Snowmobile Oils and Lubricants</i>	93
<i>Digital Caliper</i>	90	<i>Snowmobile Lifts and Dollies</i>	92
<i>Exhaust Spring Removal Tools</i>	89	<i>Throttle Position Sensor Tester</i>	91
<i>Fluid Evacuator</i>	90	<i>Toolkits</i>	95
<i>Flywheel Pullers</i>	90	<i>Track Clip Tools</i>	89
<i>Impact Screwdriver</i>	94	<i>Tension Adjustment Scale</i>	89

Description	Part #	Price (G)
Quik Shift 90 Series Magnum Gold Clutches	725-012	\$30.19

Description	Part #	Price (G)
Comet 94C Duster Clutches	725-021	\$40.22

Description	Part #	Price (G)
1980-89 Arctic Cat/Comet 102C/108C	725-023	\$46.92

Description	Part #	Price (G)
1996 Comet 108EXP and 108 4-Pro	725-024	\$76.44

Description	Part #	Price (G)
Power Bloc, Brut Clutches 1/2" External Threads.	725-031	\$40.22

Description	Part #	Price (G)
Power Block 9/16" External Threads	725-032	\$40.22

Description	Part #	Price (G)
1972 Arctic Cat EXT	725-011	\$46.92

Description	Part #	Price (G)
1973-92 Arctic Cat Hex Shaft Clutches Also Merc, Rupp, Sno-Jet, using Hex Clutches	725-068	\$26.83

Description	Part #	Price (G)
1990-95 Arctic Cat/Comet 108C Clutches, 1996 ZR440, 1996 models with 580 and 700 engines.	725-070	\$53.65

1993	Cheetah	1994	EXT580, EXT580-MC	1995	Z440
1994	Cheetah 340,550	1993	EXT580Z, EXT580-MC	1993-95	ZR440
1991-92	Cheetah Tour.	1993-94	EXT-EFI, EXT-EFI-MC	1993-95	ZR580
1991-95	Cougar, Cougar-MC	1995	EXT Powder Spec.	1994-95	ZR700
1990	El-tigre	1991-92	EXT-Spec.	1995	ZRT600
1991	Eli-tgre EXT, MC	1995	Panther	1995	ZRT800
1992	EXT, EXT-MC	1990-95	Prowler's		
1993	EXT550	1993-95	Thundercat, T-Cat-MC		
1995	EXT580, EXT-EFI	1991-95	Wildcat		

Description	Part #	Price (G)
Arctic Cat 6 and 9 Tower (1996-2006)	725-100	\$42.38

1995-00	Bearcat 340	1997	EXT 600	2001	Mtn. Cat 1000
1999-00	Bearcat 440 I&II	1998	EXT 600 Triple,	2001	Mtn. Cat 500 EFI
1998-00	Bearcat WT		EXT 600 Touring	2001	MC600 EFI,
1996-98	Cougar	1996	EXT EFI		MC600 VEV
1996	Cougar 2-up	1996	EXT Powder Special	1996-97	Pantera
1998	Cougar Deluxe	1996-97	Jag	2000-01	Pantera 1000
1996-98	Cougar MC	1998	Jag 340	1998	Pantera 580
1996	EFI Mtn. Cat	1998-99	Jag 440, Jag 440 Dlx,	2001	Pantera 580 EFI
1996	EXT 580		Jag 340 Dlx	1998-99	Pantera 800
1998	EXT 580 EFI	1996-97	Jag Deluxe	1998-00	Panther 340
1996-97	EXT 580 EFI Dlx.	1996	Jag Liquid	2001	Panther 370

1997-01	Panther 550,440	1995-97	Puma, Puma 2-up,	2001	ZL 800 ESR
1999-00	Panther 580 EFI		Puma MC	1997-98	ZR 440
1996	Panther Deluxe	1996-01	Thundrecat	1999-00	ZR 440 Sno Pro
1996	Panther Liquid Cooled	1996-00	Thundercat MC	1998-01	ZR 500, ZR 500 EFI
1997-98	Powder Extreme	1999-01	Triple Toruing 600	1999	ZR 500 LE, ZR 500 EFI LE
2000	Powder Special, EFI LE	1996	Wildcat, Wildcat MC, Wildcat Touring	1996	ZR 580
2000	Powder Special, 2K 600	1999-01	Z 440, Z370	1996-97	ZR 580 EFI
1997-98	Powder Special	2000	Z 440 ES	1998-01	ZR 600
1999-00	Powder Sp. 500 EFI	1999-01	Z 440 Sno Pro	2000	ZR 600 2K
2000	Powder Special 600, Powder Sp. 600 EFI	2000	ZL 440	1998-01	ZR 600 EFI
1999	Powder Sp. 600 Carb	1997-98	ZL 440	1999	ZR600 LE, ZR 600 EFI LE
2000	Powder Sp. 600EFI LE	2000	ZL 500	1998	ZR 600 EFI LE (B), ZR 600 EFI LE (W)
1999-00	Powder Sp. 700 EFI LE, 600 LE	2001	ZL 500 EFI ESR	1999-00	ZR 700
1999	Powder Special 700	2000	ZL 550	2000	ZR 700 LE
1997-98	Powder Special EFI	2000	ZL 550 ESR	2001	ZR 800
1998	Powder Special EFI LE	1999-00	ZL 600, ZL 600 EFI	1996-01	ZRT 800, ZRT 600
		2000	ZL 700	1999-06	All models

Description	Part #	Price (G)
Polaris -1 piece puller	725-201	\$29.95

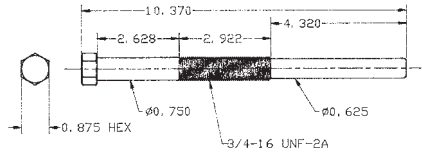

2000-01 340 Deluxe, 340 Dlx-Tour.	1987 440SKS	1989-97 500SKS
1999-00 340 Touring	1997 440XC	1985-87 600 Indy's
1996-97 440L/C	1992-97 440XCR	1988-92 650 Indy's
1993-95 440SKS	1990-97 500L/C,Carb,EFI	2000 600 Triumph
	1996-99 500RMK	1997 600XC

1989-98 Classic's	1985-87 Longtrack	1984-98 Trail Indy's, RMK, SKS, Dlx
2000-01 Classic's	1991-97 RXL650's	1996-99 Trail Touring
1996-01 Classic Tour.	1987-99 Sport	1996-99 Transport
1993-94 Classic Tour.	1990-92 Sport-GT	1996-98 Ultra's, RMK, SKS, Touring, SPX
1985-91 Indy 400	1995-99 Sport Tour.	1990-93 Widetrack
1992-95 Indy 440	1989 Sport Tour.	1994-97 Widetrack GT
1998 Indy 440	1986-90 Sprint, Sprint ES	1994-01 Widetrack LX
1989-98 Indy 500	1987-90 Star	1997 XCF
2000-01 Indy 500	1985 Star	1995-98 XCR600
2000-01 Indy 500 Classic	1985-86 Star SS	1998 XCR700
1985-87 Indy 600	1987-90 Startrack	1993-99 XLT's, RMK, SKS, Tour., LTD, Classic
1988-92 Indy 650	1993-95 Star Lite	
1991-98 Indy Lite, Lite-Dlx	1993-97 Storm, RMK, SKS	
1993-96 Lite-GT	1994-97 Supersport	
1987-89 Longtrack Reverse	1989-92 Supertrack	

Description	Part #	Price (G)
Fits: Qick Shift Clutches, Polaris P-85 & P-90 Deep Bore	725-203	\$40.22

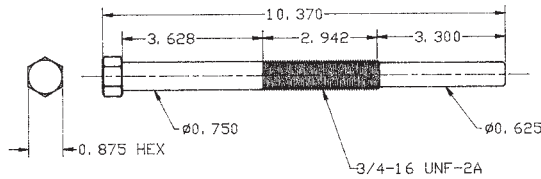

Description	Part #	Price (G)
Ski-Doo -oem #529-0250-00	725-204	\$49.49

1993 Mach-Z 780 with an OEM F1 Comet Clutch 40mm PTO Taper)

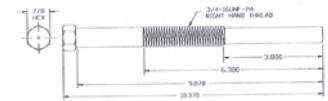

Description	Part #	Price (G)
Polaris -US Twins	725-206	\$53.65

1997-98 US Twins	1999 600XC, 600XC-SP
1997-99 700RMK	1997 700SKS
1999 700SKS	1998-99 700XC

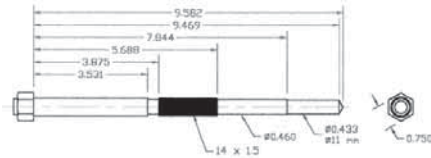

Description	Part #	Price (G)
Polaris -1 piece puller	725-207	\$33.52

1999-03 440 XC Edge	2001 600 Classic Tour.	2001 700 Classic	2000-01 800RMK
2000-01 500RMK	2000 500SKS	2000-01 700RMK	2001 800XC
2000 500SKS	2000-01 500XC, 500XC-SP	2000-01 700SKS	1999-03 800XCR
2001 600 Edge-X	2000-01 600RMK	2000 700XC, Dlx	2000-07 US Twins 500/600/700/800/900
2000-01 600RMK	2000 600XC, Dlx	2000-01 700XC-SP	
2000 600XC, Dlx	2000-01 600XC-SP	1999 700 XCR	



Description	Part #	Price (G)
Ski-Doo oem #529-00021-00	725-402	\$40.22

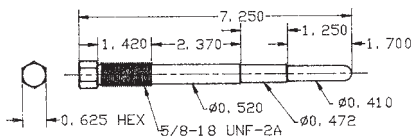

1983-87 Alpine	1979-81 Blizzard 5500
1979-81 Blizzard 5500	1984 Blizzard 5500 MX
1984 Blizzard 5500 MX	1982 Blizzard 5500 MX
1978 Blizzard 6500 Plus	1979-81 Blizzard 7500
1979-81 Blizzard 7500	1979-82 Blizzard 9500
1979-82 Blizzard 9500	1983-84 Blizzard 9700

1979 Blizzard Cross Country	1985-86 Formula Mx	1988 Safari 377E
1981 Blizzard Mx	1985 Formula Plus	1986 Safari 447
1980-92 Elan	1986 Formula SP	1984 Safari 447
1979 Elan 250, Elan Dlx.	1985 Formula SS	1984-85 Safari 477
1978-82 Elite	1985 Mirage III	1986 Safari GL LC
1978-79 Everest 340, Everest 440	1987-89 Nordik 50, Nordik 60	1985 Safari Grand Lux
1979 Everest 444	1991 Nordik 50, Nordik 60	1989 Safari Saga
1980-82 Everest 500	1978-79 Olympique	1989-90 Safari Scout
1980-82 Everest LC	1978 RV 340	1989 Safari Scout E
1987 Everest LC	1987 Safari	1984 Safari SS-25
1978 Everest LC	1984-86 Safari 377, Safari 377E	1987 Skandic
		1978 TNT F/A TNT F/C

Description	Part #	Price (G)
Ski-Doo -oem #529-0028-00 & 529-0030-00	725-401	\$40.22
Replacement pin	725-411	\$21.46

1984 Citation	1985-87 Citation LS,LSE	1984-87 Skandic R
1987 Citation	1981 Citation SS	1983 Skandic 277,377
1980 Citation	1981-82 Nordik	1985-87 Tundra,Tundra LT
1981-83 Citation 3500	1982 Skandic	1987 Tundra LTS
1981-83 Citation 4500	1984-86 Skandic	

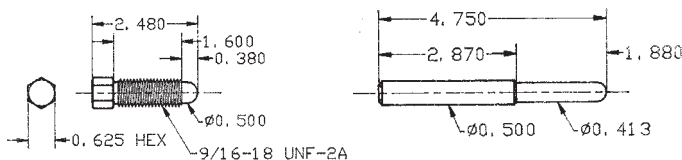

Description	Part #	Price (G)
Polaris -1 piece puller	725-208	\$33.52

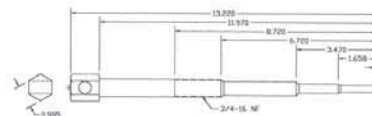

2000-01 Sport Touring
2000-01 Supersport
2000-01 Trail, Trail-RMK
2000 Trail Touring

Description Part # Price (G)

Ski-Doo -Puller 725-413 \$46.92

- 1993-94 Alpine II
- 1990-91 Alpine II
- 1990 Alpine IV
- 1991 Cheyenne
- 1997-00 Formula 500,Dlx,
- 1997-99 Formula 583
- 1991 Formula MX
- 1993 Formula Gr. Tour.
- 1990-92 Formula Mach-1, Mach-1-XTC
- 1991 Formula Mach-1X



- 1994 Formula Mach-Z
- 1988-94 Formula MX
- 1993-94 Formula MXZ
- 1989-93 Formula Plus ,X,E, XTC,EFI
- 1995-99 Formula SL

- 1996 Formuls SLS
- 1999 Formula ST
- 1995-96 Formula STX
- 1999 Formula STX
- 1991-92 Formula XTC
- 1995-99 Formula Z-583

- 1999 Formula 500
- 1995 Grand Tour. 470
- 1996-98 Grand Tour. 500
- 1995-96 Grand Tour. 580
- 1994-99 Grand Tour. 583
- 1994 Mach-1, Mach-1 GT, XTC
- 1995 MX
- 1999-00 MXZ440
- 1996 MXZ440
- 1997-98 MXZ440F
- 2001 MXZ440F, MXZ500F
- 1997 MXZ440LC
- 1998 MXZ500
- 1996-98 MXZ583

- 1993 Safari 503 Rally
- 1990 Safari Cheyenne
- 1993-94 Safari Dlx.
- 1990-92 Safari GLX
- 1990-94 Safari L
- 1990-91 Safari LC
- 1992 Safari LCE
- 1990-92 Safari LE
- 1990-91 Safari LX,LXE
- 1994 Safari Rally E
- 1994 Skandic
- 1995-00 Skandic 500
- 1994 Skandic 503R, 503R-SLT

- 1992 Skandic II, IIR
- 1993 Skandic II 377,377R
- 1993 Skandic II 503, 503R
- 1998 Skandic Super WT
- 2000 Skandic SWT,WT
- 1995-98 Skandic WT
- 1994 Summit 470
- 1996-98 Summit 500
- 2001 Summit 500F
- 1994-98 Summit 583
- 1999-00 Touring LE
- 1996-97 Touring LE
- 1999-00 Touring SLE
- 1995-97 Touring SLE

Description Part # Price (G)

Ski-Doo -oem #529-0224-00 725-414 \$29.95

- 2001 Formula 500 Dlx.
- 2000-01 Formula 600 Dlx.
- 1999 Formula 670 Dlx.
- 2000-01 Formula 700 Dlx.
- 1996-98 Formula III
- 1998-99 Formula III 600
- 1998-00 Formula III 700
- 1999-00 Formula III 800
- 1993 Formula Mach-1, XTC
- 1995-96 Formula SS
- 2000 Formula Z 600
- 1998-99 Formula Z 670
- 2000 Formula Z 700
- 2001 Grand Tour. 500
- 1999 Grand Tour. 500
- 2000-01 Grand Tour. 600

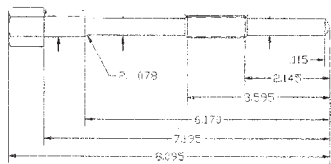

- 1998-01 Grand Tour. 700
- 1997-00 Grand Touring SE
- 1995-99 Mach-1
- 1998-00 Mach-1R
- 1995-01 Mach Z's
- 1996-99 MXZ670,
- MXZ670HO
- 2000 MXZ700
- 1999-01 Summit 700
- 1998 MXZ440LC
- 1998 MXZ440LC
- 1998 Skandic WT LC
- 1999 Summit 500
- 1999-01 Summit 600
- 1995-98 Summit 670,
- Summit-X 670
- 2001 Summit 700
- 2001 Summit 800
- 2000 Touring 500LC

Description
Fits all Kawasaki Built Clutches
1978-82 Intruder, Invader, Ltd

Part # Price (G)
725-501 \$29.95

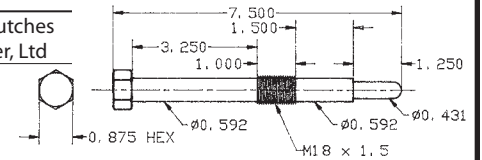

Description Part # Price (G)
Yamaha -Free Air except Splined Crank Models 725-601 \$40.22

- 1974-75 GPX 338 / 433
- 1976 STX 340 / 440
- 1979 ET 300
- 1976-77 EX 340 / 440

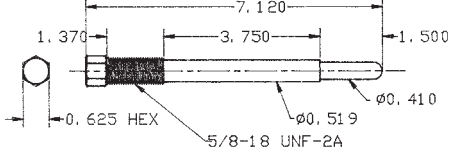

Description Part # Price (G)
Yamaha 1985-2004 YPZ & YXR Clutches 725-603 \$29.95
oem# Y5-01881-1

- 1987-01 Bravo
- 1999 CS340EC
- 1990 Enticer
- 1992-95 Enticer
- 1989 Enticer 400
- 1985-86 Excel V
- 1988 Excel V
- 1990 Excel V
- 1997-01 Mtn. Max's
- 1989-90 Ovation
- 1992-98 Ovation
- 1984-01 Phazer's
- 1985-91 SRV's
- 1998-01 SRX600,700
- 1984-85 SS440
- 2000-01 SX500,600,700

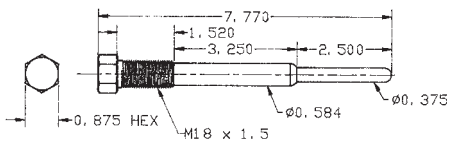

- 1991 Venture
- 1995 Venture
- 1997 Venture
- 2000 Venture
- 1996-98 Venture 480
- 1997-01 Venture 500
- 1997-01 Venture 600
- 1998-01 Venture 700
- 1992-94 Venture GT
- 1992-94 Venture XL
- 1999-00 Venture XL
- 1988-98 Viking
- 1985 V-max
- 1992 V-max
- 1997-01 V-max 500
- 1997-99 V-max 600
- 1997-00 V-max 700
- 2000-01 V-Max
- 500,600,700
- 2000 SX700R, SX600R

Description Part # Price (G)
Yamaha SRX & Exciter Models 725-602 \$33.52
- Threads 18mm x 1.5mm

- 1981 EC340E
- 1984 Enticer
- 1985-88 Enticer
- 1979-83 Enticer 340
- 1979-81 Exciter 440
- 1983-88 Excel III
- 1980-81 SS440
- 1981 SR540
- 1979-81 SRX440

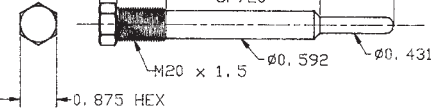

ATV Clutch pullers



Fitment	Part #	Price (F)
Polaris ATV All 1985-03	PCP-1	TBA
Polaris ATV All Secondaries 1985-03	SCP-1	\$34.62
Kawasaki ATV 300/400/500/650 Prairie (all)	PCP-10	\$46.93
Kawasaki Mule 3000 series (all)	PCP-10	\$46.93

Description Part # Price (G)
Yamaha 1983 V-max with OEM Comet Clutch 725-604 \$26.83

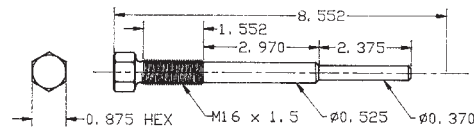

Miscellaneous Clutch Tools

Fitment	Part #	Price (D)
Grunt Tool Set Comet	C213966	\$67.71
Grunt Tool Set Kimpex	003-447	\$105.95
Tapered Half Tool only	C213965	\$26.03
108 EXP Clutch Puller (before 1995)	C216097	\$24.31
102C On Yamaha's Clutch Puller	C211314	\$49.95
Fits:217101,107,204,207,503,504,507, 600,604,607 (1997-2003 production)	015-2246	\$49.95
All other # "217" clutches use this puller (1994-96 production)	C217153	\$70.55

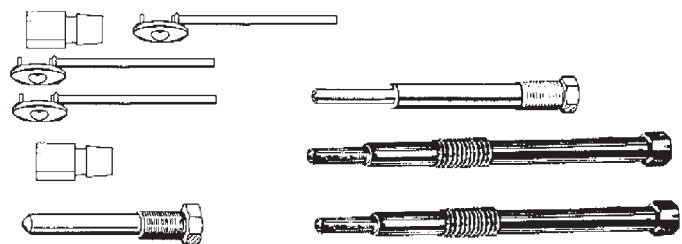

Fitment	Sno-Stuff USA Made			Taiwan Made			Erlandson USA Made		
	Style	Part #	Price (G)	Style	Part #	Price (D)	Style	Part #	Price (D)
Arctic Cat									
'73 Clutches 5/8 X 18 N.F.	-	-	-	-	012-164-2	\$16.95			
All Hexagon-Shaft Clutches (9/16" thread size) '73-'93	(2)	725-068	\$26.83	(2)	012-164-12	\$19.95			
Comet 108C,108EXP with std bolt (3/4"-16 thread)	(3)	725-023	\$46.92						
Comet 100,101C,102C,108C	(3)	725-201	\$29.95	(2)	012-164-19	\$19.95			
Comet 108EXP w/countersunk mount-bolt '89-'94 (7/8-14 thread)	(1)	725-070	\$53.65				(2)	PCP-2	\$53.64
							(2)	CPE2	\$44.25
Comet '96-'99 108EXP & 4-Pro Clutch #'s	(4)	015-2246	\$49.95						
217101,107,204,207,503,504,507,600,604,607	(4)	015-2246	\$49.95						
All other # "217" clutches use this puller	(4)	C217153	\$70.55						
All "Artco" Clutches '96-'03	(2)	725-100	\$42.38	(2)	012-164-16	\$26.95	(2)	CPE5	\$40.74
Comet '96-'97 108 EXP and 108-4 PRO clutches	(3)	725-024	\$76.44						
Polaris									
P85-P90 Clutches with 4.3" Pin length	(3)	725-201	\$29.95	(2)	012-164-19	\$19.95			
P-85-P90 & Magnum Gold Clutches	(3)	725-203	\$40.22				(2)	CPE1	\$36.36
with 3.3" Pin length (3/4-16 threads)							(2)	CPE1	\$36.36
98-99 500,600,700 USA Twins (except 1999 440 edge)	(2)	725-206	\$53.65				(2)	PCP-7	\$64.38
							(2)	CPE7	\$40.74
2000-07 US Twins, 99-03 440 XC Edge , 99-03 700/800 XCR	(2)	725-207	\$33.52	(2)	SM-12305	\$29.95	(2)	CPE8	\$48.41
'99-'03 All Fuji Engines except following: (XCR700,800=PCP-8) (340 Dlx=PCP-1)(500 Carb classic=PCP-1)(600 Triumph= PCP-1)							(2)	PCP-9	\$67.07
							(2)	CPE9	\$48.41
Ski-Doo									
'93 Mach Z 780, F1 Comet OEM 40mm PTO	(3)	725-204	\$49.49						
Metric puller used on Citations & Mirages	(1)	725-401	\$33.52						
Replacement pin for above; # 725-401		725-411	\$21.46						
Standard clutch puller (square shaft style) (5/8"-18 thread)	(2)	725-402	\$40.22	(2)	012-164-7	\$16.95			
Ski-Doo TRA Clutch (14mm X 1 mm thread) oem#529.0079.00	(2)	725-413	\$46.92	(2)	012-164-13	\$18.95	(2)	PCP-4	TBA
'86 Formula Plus • '87 Escapade, Formula MX, Plus, Statos • '88 Escapade, Formula MX, Plus, Stratos • '89 Alpine II, '88 Escapade, Formula MX, Plus, Stratos • '89 Alpine II, Formula 500,MX, Plus, Safari Cheyenne, Escapade, Voyageur, '90 Alpine II, Formula 500, MX, Plus, Mach-1 583, Safari Cheyenne, Scout, Safari L,LC,LE,LX,LXE,GLX • '91 Alpine II,Formula MX, Plus, Mach-1 617, Safari Cheyenne, Scout L,LE,LCE,LXE,GLX • '92 Formula MX, Plus, Plus-X, Safari L,LE,LCE,GLX, Skandic II,Tundra • '93-'97 All Formula's (except 670's) Grand Tour.583 , Safaria, Skandic II, Summit 500,583, Tundra's • '95-'97 MX-Z 440,500,583							(2)	CPE4	\$38.19
Ski-Doo TRA '93-'97 Mach 1 670 • oem# 529.0224.00	(2)	725-414	\$29.95	(2)	012-164-18	\$19.95	(2)	CPE3	\$36.36
'94-'99 Gr-Tour SE670 * '95-'99 Formula SS '96-'97 MX-Z 670 • '95-'99 Formula III 600,700 • '95-'99 Summit 670 • '98 CK-3 Chassis Mach Z (800)'98 CK-3 Chassis Mach Z (800)									
Yamaha									
'74-'75 GPX, '76 STX 340/440, '79 ET 300, '76 EX340/440 (5/8"x18 thread)	(2)	725-601	\$40.22						
(20mm X1.5 threads) '81-'88 EC 340, '76-'80 SRX,'78-'88 ET 340, '77-'78 EX 340,'77-'79 EX 440,'80EC540	(3)			(2)	012-164-14	\$19.95			
YPZ & YXR Clutches 85-86 Phazer, 85-86 SRV, 85 SS440, 92-93 V-Max 4, 85-86 Excel-V, 97-04 V-Max 500, 600, 700 (18mm x 1.5 thread)	(3)	725-603	\$29.95				(2)	PCP-6	\$46.93
Comet, V-Max 1983 (16mm x 1.5 threads)	(3)	725-604	\$33.52				(2)	CPE6	\$34.38
79-ET300 • 81-84 ET250,300 • 82 SRV • 82-86 Bravo's • 84-96 Phazer's • 76 STX340,440 • 74-75 GPX338,433 • 92-96 V-max 4's • 95-96 V-max 500-600's				(2)	012-164-10	\$18.95			
Miscellaneous Pullers									
Rupp Clutches				(2)	015-870	\$16.95			
Early Quikshift & 72 EXT Round shaft clutch (7/8"-9 thread)	(2)	725-011	\$46.92						
Quikshift '85 and older models (9/16"-18 thread)	(2)	725-012	\$30.19						
Comet 94C Duster clutches (9/16-18 thread size)	(2)	725-021	\$40.22						
Polaris, Powerbloc-Brut (1/2" external threads)	(2)	725-031	\$40.22	(2)	015-872	\$16.95			
Powerbloc (9/16"-18 external threads)	(2)	725-032	\$40.22						
Kawasaki w/hex clutch '78 Intriguer 440, Inviter 340 '79-'80 Drifter 340, 440	(2)	725-068	\$26.83	(2)	012-164-12	\$19.95			
Kawasaki made clutches (18mm) '78-'82 Intruder/Invader/LTD	(4)	725-501	\$29.95	(2)	012-164-9	\$19.95			



Drive Clutch Compressor Tool

Compresses drive clutches for easy cam arm changes.



725-183

725-283
003-448
P2871173

Description	Part #	Price (F)
Artco Drive Clutch Compressor Tool	725-183	\$26.76
Universal Clutch Compressor Tool	003-448	\$29.95
Polaris & Comet Drive Clutch Compressor Tool	725-283	\$26.76
Yamaha	725-683	\$26.76

**Clutch Spider Tool
by Sno-Stuff**

- Fits Artco Clutches

Description	Part #	Price (F)
Spider Tool	725-185	\$93.81

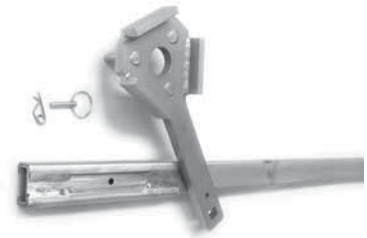

Clutch Spider Tools

Description	Part #	Price
Spider Nut Tool fits; Polaris Spider lock nut	725-286	\$53.95 (G)
Spider Tool fits; all Polaris Clutches	725-285	\$53.95 (G)
Spider Nut Tool fits; Artco Clutch Spider nut	725-186	\$43.95 (G)
Spider Tool fits Arctic Cat and Polaris Clutches	STA20-75	\$59.95 (E)

725-286



725-186
725-285



STA20-75



**Clutch Tools
for P85 & P90 clutches**

Clutch Holding tool fits all Polaris snowmobile & ATV clutches. A must for all clutch rebuilders.



Description	Part #	Price (D)
Polaris	725-280	\$81.81

Arctic Cat Clutch Holding Tool by Sno-Stuff

Bolts down to your work bench for easy disassembly and assembly.



- 33mm fits Artco Clutches
- 30mm fits Comet 102 & 108's

Description	Part #	Price (D)
Arctic Cat 30mm clutch	725-180	\$53.59
Arctic Cat 33mm clutch	725-181	\$53.59

**Clutch Tools
for Polaris & Artco clutches**

Clutch Holding tool fits all Polaris & Artco snowmobile & ATV clutches. A must for all clutch rebuilders.



Description	Part #	Price (D)
Artco clutches	STA20-192	\$98.02
Polaris	STA20-162	\$98.02

Clutch Sheave Holding Tool

- Holds clutch together when changing weights without removing cover.



Description	Part #	Price (G)
Clutch Sheave Tool	20-86	\$9.95

Belt Removal Tool



Description	Part #	Price (D)
Polaris Belt Removal Tool	930002	\$7.57
Team Secondary Removal Tool	930002	\$7.57
Ski-Doo Belt Removal Tool	SM-12367	\$6.95

TRA Retainer Clip Set

When installing TRA buttons this tool holds all 6 buttons in place while assembling clutch. A must for all shops. Comes in a set of 3

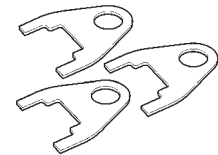

Description	Part #	Price (D)
TRA Retaining clip set	28-505	\$26.95

Weight Bushing Replacing Tool

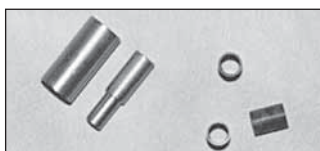

Description	Part #	Price (G)
Weight Bushing Tool	15-500	\$14.95

**Spider Roller Tool
for Polaris clutches**



Description	Part #	Price (F)
Roller Tool	725-287	\$26.76

Spider Aligning Tool for Polaris

- The simplest tool for removing pin and rollers from Polaris spiders. Aligns all parts perfectly.

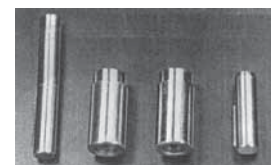

Description	Part #	Price (G)
Spider Aligning Tool	STA20-85	\$31.95

**SLP Button Tool
for Polaris Drive Clutches**

Remove spider buttons quickly and easily without damage with this new tool from SLP. Tool uses a precision collet to lock around the outside of the button. It's ergonomical pistol grip shape allows you to lock onto the button, remove it, and release it with ease.



Description	Part #	Price (D)
SLP Button Tool	STA20-180	TBA

**Button Removal Tool
for Polaris**

- The only proper way to remove polaris spider buttons

Description	Part #	Price (E)
Button Removal Tool	STA20-77	\$50.66
Button Removal Tool	725-288	\$26.76
(imported)	SM-12187	\$24.95



Clutch & Flywheel Holding Tools

An excellent tool for every shop. Ideal for holding the Clutch when removing and installing.

Description	Part #	Price (F)
TRA Clutch Holder	28-500	\$22.95
Polaris/ A-Cat Clutch Holder	28-501	\$22.95
Polaris Flywheel Holder	28-509	\$25.95

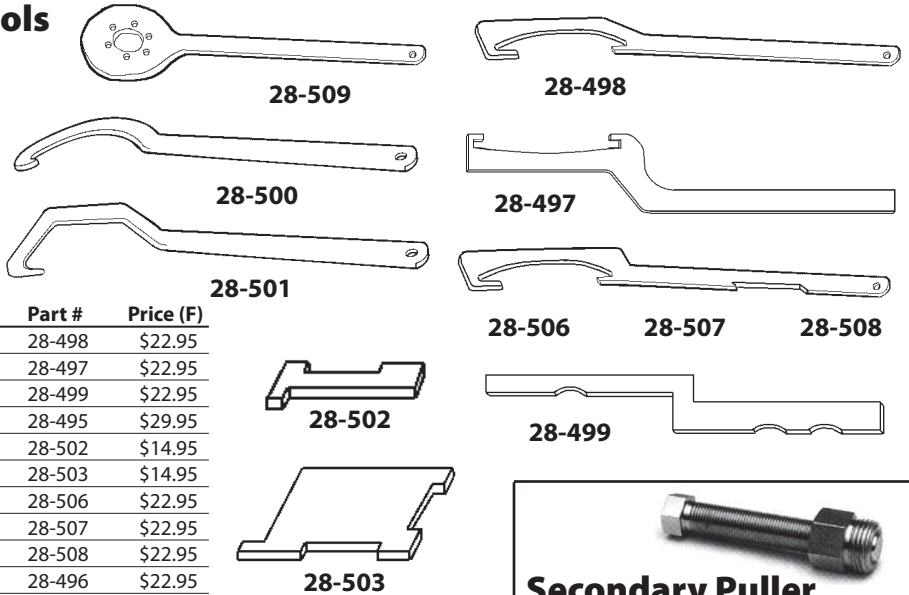

Clutch Offset Aligning Tools

Description	Part #	Price (F)
Polaris Offset Tool P-85 clutches 1980-2001	28-498	\$22.95
Offset Tool A-Cat w/Artco Primary ,Comet Secondary	28-497	\$22.95
Offset Tool A-Cat w/Comet Drive ,Comet Secondary	28-499	\$22.95
Offset Tool Polaris with Team Secondary	28-495	\$29.95
Offset Tool Ski-Doo F2000,S2000 (toolbox size)	28-502	\$14.95
Offset Tool Ski-Doo CK-3 Chassis (toolbox size)	28-503	\$14.95
Offset Tool Ski-Doo F2000,S2000	28-506	\$22.95
Offset Tool Ski-Doo CK-3 Chassis	28-507	\$22.95
Offset Tool Ski-Doo Rev Chassis	28-508	\$22.95
Yamaha Offset Tool 97-up YPZ-clutches	28-496	\$22.95

**Secondary Puller
for Polaris**

Genuine Polaris secondary clutch puller for use on 750 Storm (1993).

Description	Part #	Price (D)
Made in USA	SCP-1	\$34.62
Made in Taiwan	AT-12056	\$21.95



Clutch Alignment Tool

Check and set clutch alignment quickly and easily with this precision tool, which slides over clutch fixed sheave for accuracy.

Description	Part #	Price (F)
For Polaris TSS-98	930203	\$45.52
For Polaris TSS-04	930716	\$52.55
For Ski-Doo REV TSS-98 2003-07, RT Chassis 1000 2005-07	930204	\$52.55
For Ski-Doo 1999-2002 TSS-98	930206	\$52.55
For Ski-Doo REV TSS-04 2003-07, RT Chassis 1000 2005-07	930715	\$52.55
For Ski-Doo 1999-2002 TSS-04	930717	\$52.55



Clutch Service Tool

Introducing a revolutionary new tool for servicing Polaris or Comet drive and driven clutches. For drive clutches the SLP tool will compress the spring for easy cam arm changes, or cover bolt removal. For driven clutch service, the SLP tool will compress the helix and hold it in place for snap ring installation. Wrestling with the clutches or needing a friend to help is now history with this amazing tool. A great time saver for every racer and mechanic.

Description	Part #	Price (E)
Polaris Clutch service tool	STA20-99	\$119.95
Skidoo Clutch service tool (non RER)	*STA20-128	\$119.95
Arctic Cat 97 ZR style tool	STA20-130	\$80.00
Arctic Cat & Yamaha	STA20-134	\$119.95
Replacement buttons for above	STA20-131	\$1.50
Rapid Reaction Finger Kit – pair	STA20-171	\$19.95

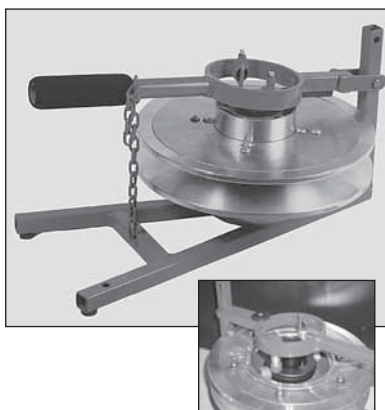

**MTX Rivet Set and
Removal Tool**

Allows you to fine tune your MTX weights quickly and easily by setting or removing rivets. Specifically designed to be used in the field (but can be clamped for shop use). Also sets and removes Yamaha Clutch weight rivets.

Description	Part #	Price (E)
MTX Rivet Tool	STA20-155	\$74.95

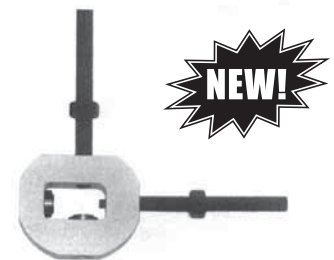

Driven Clutch Puller for Arctic Cat by Sno-Stuff

A universal design that will work on all 1981 and newer reverse cam secondary clutches with button or roller covers.

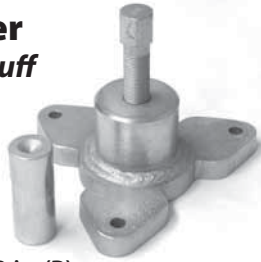

Description	Part #	Price (D)
Driven Clutch Puller	725-182	\$66.98

Bench Mount Clutch Compression Tool for Diamond Drive Clutch

Designed specifically for the Diamond Drive clutch found on many late model Arctic Cats. This tool makes assembly and disassembly of this complex clutch a breeze. Comes complete with a TSS clutch Tool (Part # STA20-166). Also supplied with a number of adapters that allow it to work with most other driven clutches including Team Rapid Reaction, Arctic Cat 1992 and newer, and Polaris button clutches.



Description	Part #	Price (D)
Diamond Drive	STA20-167	\$304.95

Multi-Purpose Clutch Tool for Arctic Cat with Diamond Drive

Multi-purpose tool that allows effortless belt changes, belt deflection adjustments and driven spring tension adjustments. Designed to work in conjunction with the BD Belt Deflection Adjuster (Part #STA20-157 or Part #STA20-158) and the BD Spring Tool (Part #STA20-159).



Description	Part #	Price (D)
Diamond Drive 2004-06	STA20-166	\$44.95
Diamond Drive 2007	STA20-178	\$44.95

Belt Deflection Adjuster for Arctic Cat with Diamond Drive

Insure proper belt deflection is maintained with this strong aluminium belt deflector adjuster.



Description	Part #	Price (D)
2004-2005 ZR 900, 2005 Firecat, 2004 T660 (Right hand thread)	SW-50034	\$21.77
2005-07 M-Series, T660 (Left Hand Thread)	STA20-158	\$22.95

Diamond Driven Adjustment Tool for Arctic Cat

Description	Part #	Price (F)
Driven Adjust Tool	28-510	\$29.95



Spring Tool for Arctic Cat with Diamond Drive

Easily fine tune your clutching by changing the driven clutch spring tension with the use of this handy tool.



Description	Part #	Price (D)
Diamond Drive	STA20-159	\$24.95



Spring Compression Tool

For RER Skidoo Driven Pulleys. Change helix or springs easily and safely with this SLP spring compression tool. Designed to be used in a vise or mounted to a bench.

Description	Part #	Price (E)
Spring Compression Tool	STA20-143	\$84.87

Diamond Drive Track Socket and Nut

This socket is required to remove track, brake or driveshaft from the sled. The nut is a locking nut that needs to be replaced if removed.



Description	Part #	Price (D)
2004-06 Diamond Drives		
Track Socket	STA20-168	\$45.95
Brake Retainer Nut	STA20-169	\$8.95
2007 Diamond Drives		
Track Socket	STA20-176	\$45.95
Brake Retainer Nut	STA20-177	\$8.95



Clutch Compression Tool

Allows one person to compress clutches for service work, remove and install helices, change springs and maintenance.

- Snowmobile** Polaris, Arctic Cat, Yamaha, and Comet Primary clutches. Skidoo RER Driven Pulleys
- ATV** Yamaha, Arctic Cat, Suzuki Secondary clutches Polaris, Kawasaki, and Comet Primary clutches Kawasaki 360 & 650 Prairie Secondary clutches

Description	Part #	Price (F)
Clutch Compression Tool	CCT500	\$107.37

Clutch Spring Compressor

Uninstall and remove primary springs safely on your TRA primary clutches. Mounts to vise or can be drilled and mounted to your bench.



Part #	Price (F)
CCT700	\$71.84

Spring Installation Tool

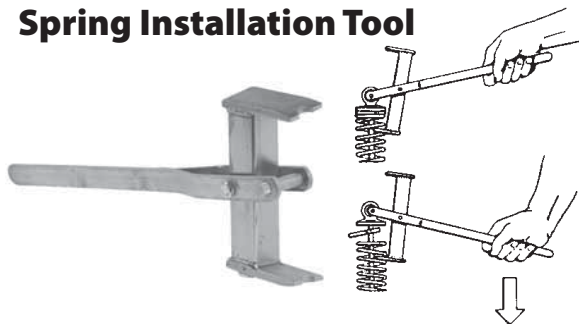

Description	Part #	Price (E)
Spring Installation Tool for Shocks	STA20-83	\$33.95

Shock Spring Installation Tool

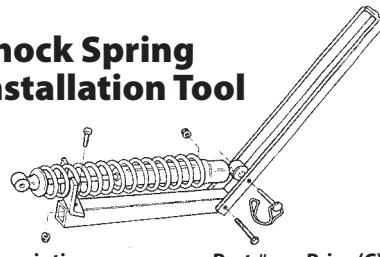

Description	Part #	Price (C)
Spring Installation Tool	28-121	\$54.95

Extension Spring Tool

An excellent tool for every shop. Ideal for removing exhaust springs.



Part #	Price (D)
STA20-133	\$42.95

Shock Spring Adjusting Tool



Description	Part #	Price (D)
Shock Spring Adjusting Tool	004-1279	\$10.95

Spring Adjustment Tool



Description	Part #	Price (G)
Spring Adjustment Tool	SM-08003	\$15.95

Snap Ring Pliers



- External & Internal

Description	Part #	Price (D)
Snap Ring Pliers	015-856	\$7.95

Track Clip Pliers



Description	Part #	Price (G)
wide clips (1.5")	004-149-12	\$79.95

Track Clip Tool Kit



Sno-Stuff has taken their existing track clip tools and inserted them in a great carrying case. Fits both wide and narrow track clips.

Description	Part #	Price (D)
Track clip tool kit	725-005	\$107.24
Parts		
Guide bolts	725-000-201	\$5.50
Centre screws	725-000-405	\$22.31
Wide insert	725-000-407	\$39.95

Exhaust Spring Removal Tools

Description	Part #	Price (E)
Exhaust Spring Tool	725-900	\$19.46
4" Size	STA20-89	\$13.95
6" Size	STA20-90	\$14.95

Description	Part #	Price (F)
Exhaust Spring Tool	M/P08-065	\$12.95



STA20-89
STA20-90

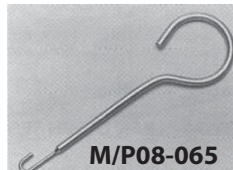

M/P08-065



725-900

Tension Adjustment Scale

Finally an easy method of measuring and setting tension. This new scale has a range 0-25 lbs. It is very accurate and has a "tattle tale" marker to help measure more precisely. Works excellent for secondary clutch breakaway tension, track tension, water pump belt deflection, etc.



Description	Part #	Price (D)
Tension Adjustment Scale	STA20-182	\$41.95

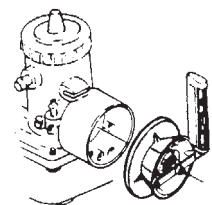

Uni-sync Carb Synchronizer

Description	Part #	Price (A)
Uni-sync Carb Synchronizer	014-139	\$54.07

Piston Pin Puller

Description	Part #	Price (D)
Piston Pin Puller	012-610	\$21.95

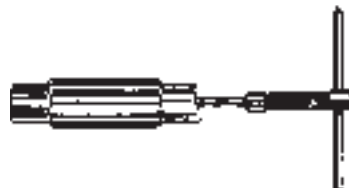

Carb Leak Detector

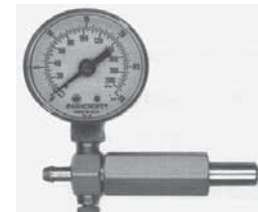

Description	Part #	Price (D)
Carb Leak Detector	007-400	\$55.95

Polaris Flywheel Puller

Comes w/high quality grade 10.9 bolts.

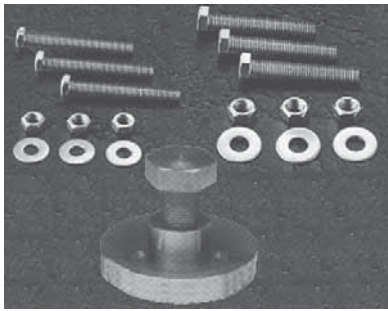

Description	Part #	Price (E)
Polaris Flywheel Puller	STA20-135	\$59.95

Universal Flywheel Puller

Comes w/high quality 6mm & 8mm bolts



Description	Part #	Price (E)
Universal Flywheel Puller	009-620	\$39.95

Maximum Flywheel Puller for Polaris

Snowmobiles, Watercraft, ATV. Comes w/ high quality grade 10 bolts, 6mm and 8mm

Description	Part #	Price (E)
Flywheel Puller	STA20-142	\$132.95



Flywheel Puller Universal

Comes w/high quality 6mm & 8mm bolts

Description	Part #	Price (F)
Flywheel Puller	725-010	\$40.22

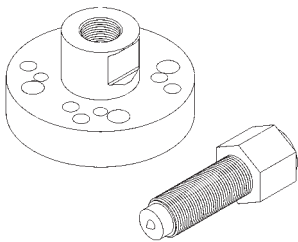

IN-12072 Fluid Evacuator (7.3 Liter capacity)

- Fluid Evacuator creates vacuum.
- Large capacity: 7.3 liters.
- Provides a clean, fast and simple way to evacuate a wide range of fluids.
- Includes five feet of flexible hosing and two rigid dipstick tubes for engine oil removal.
- Automatic shut off valve prevents overfilling— shuts off at 7.3 liters.
- Sturdy base with exterior pump prevents evacuator from tipping.
- No electrical or compressed air required.
- Can be used to bleed hydraulic brake systems in conjunction with brake bleeding access kit.
- Durable Polyethylene construction is impervious to automotive and household chemicals.
- Can be used to evacuate wide range of fluid types:
 - Engine Oil, Transmission Fluids, Gear Oil, Coolant, Brake Fluid, Other Fluids.



Description	Part #	Price (E)
Fluid Evacuator	IN-12072	\$94.95



Engine Location Tool

A must for every high performance shop. Save time and shop labour using this new Engine Location Tool.

Model	Part #	Price (D)
Yamaha	28-366	\$39.95

LiquidVac

Quickly and easily remove old oil or anti-freeze without the mess. Simply insert the suction hose into the dipstick tube or coolant bottle, then apply a vacuum to the LliquidVac tank with several strokes of the high volume hand pump. The LliquidVac's powerful vacuum action quickly draws the old fluid into its big 2 gallon capacity tank.



Description	Part #	Price (A)
LiquidVac	STA20-148	\$75.95

Compression Tester (small)

Only 7½" long this great little high quality compression tester has the snowmobiler in mind. Comes with both 14 mm & 18 mm thread sizes. A great item for any Snowmobile, ATV, or Watercraft Shop.



Description	Part #	Price (A)
7½" Long Compression Tester	STA20-149	\$37.95

Dial Indicator Tool



Description	Part #	Price (A)
Dial Indicator	STA20-92	\$78.95

Degree Wheel



Description	Part #	Price (E)
Degree Wheel	STA20-91	\$22.95

Piston Light

This flexible Bend-A-Light is a must for all snowmobile tuners. With a high intensity bulb it is perfectly suited for reading your piston wash. Also works great for lighting hard to see areas when wrenching on your sled, atv, or watercraft.



16102 **11" Mini-Pro Bend-A-Light**

- High intensity flexible light bends and holds any position
- Amazing brightness for tight situations, 3/16" Diameter Bulb
- 5" Flexible brass alloy shaft
- Pocket clip acts as switch
- 2 AAA alkaline batteries (included)



10150A **16" Bend-A-Light Pro**

- High intensity flexible light bends and holds any position
- Amazing brightness for tight situations, 3/16" Diameter Bulb
- 10" Flexible brass alloy shaft
- Protective cover can also be used as an extension
- 2 AA alkaline batteries (included)



10250A **16" Micro-Pro Bend-A-Light**

- High intensity flexible light bends and holds any position
- Ultra small bulb head, 1/8" Diameter
- 10" Flexible brass alloy shaft
- Protective cover can also be used as an extension
- 2 AA alkaline batteries (included)

Bend-A-Light®
"The Industry Leader"
Made in the U.S.A.

Bend-A-Light

Description	Part #	Price (F)
Bend-A-Light 16"	10150A	\$44.47
Bend-A-Light 16" Micro-Pro	10250A	\$53.36
Bend-A-Light 11" Mini-Pro	16102	\$35.56
Bend-A-Light Kit 16"	10355A	\$67.95
Bend-A-Light Kit 16' w/pouch	10359A	\$71.15
Bend-A-Light 24" Krypton-Pro	15150A	\$80.07

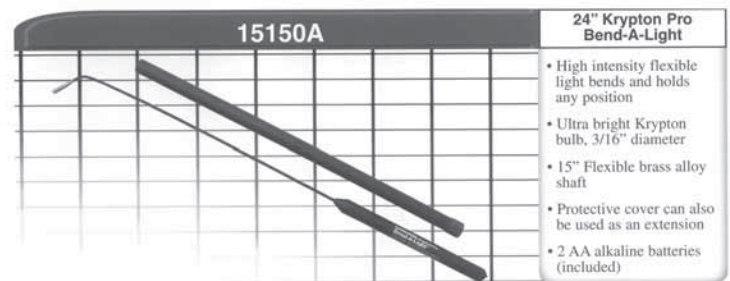

15150A **24" Krypton Pro Bend-A-Light**

- High intensity flexible light bends and holds any position
- Ultra bright Krypton bulb, 3/16" diameter
- 15" Flexible brass alloy shaft
- Protective cover can also be used as an extension
- 2 AA alkaline batteries (included)

Bend-A-Light Specifications

- Plastic handle, brass shaft

Model #	Shaft Length	Overall Length	Batteries	Lamp Dia.	Lamp		Repl. Switch	
					Part #	Price (F)	Part #	Price (F)
16102	5"	11"	2-AAA	3/16"	12100	\$14.95	-	-
10150A	10"	16"	2-AA	3/16"	12100	\$14.95	12777	\$8.95
10250A	10"	16"	2-AA	1/8"	12120	\$16.95	12777	\$8.95
15150A	15"	24"	2-AA	3/16"	12100	\$14.95	12777	\$8.95

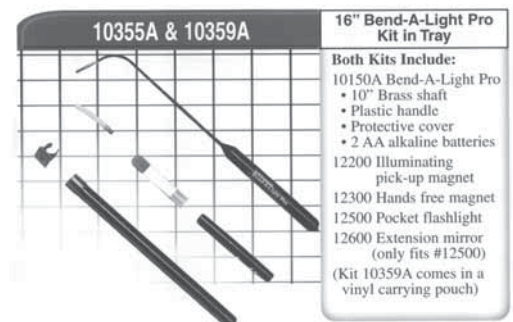

10355A & 10359A **16" Bend-A-Light Pro Kit in Tray**

Both Kits Include:

- 10150A Bend-A-Light Pro
- 10" Brass shaft
- Plastic handle
- Protective cover
- 2 AA alkaline batteries

12200 Illuminating pick-up magnet
12300 Hands free magnet
12500 Pocket flashlight
12600 Extension mirror (only fits #12500)
(Kit 10359A comes in a vinyl carrying pouch)

TPS (Throttle Position Sensor) Tester

Test and adjust your TPS setting quickly and accurately with this special tool. TPS tester kit includes wiring harness to connect to most Arctic Cat and Polaris models, as well as a special TPS Screwdriver and detailed instructions. Arctic Cat F5, F6, F7 & M-Series chassis require the optional wiring pigtail.



Description	Part #	Price (E)
Throttle Position Tester Kit	STA20-193	\$179.95
Wiring pigtail adaptor F & M A-Cats	STA20-194	\$89.95
Replacement TPS Screwdriver	STA20-195	\$20.95

Digital Pocket Scale

- Handheld design
- Minimum 0.1 g, Maximum 200 g
- Sensitivity 0.1 g
- Uses AAA batteries
- 81 mm x 116 mm x 24.5 mm
- CE Approved
- Display: grams, ounces, troy ounces
- Auto power off



Description	Part #	Price (G)
Digital Pocket Scale	IN-12306	\$59.95

Rec-Lift Snowmobile & ATV



*Freight not included

- Lifts your sled 2 feet off the ground.
- Prevents damage to suspension due to sag from sitting over the summer.
- You no longer have to work on your sled laying on the wet cold floor.
- Save your back while servicing the engine and clutches.
- A Must for all Snowmobile Shops.
- **Rec-Lift** is compact and portable.
- When not in use it can easily be stored against the wall or under a bench.

Description	Part #	Price* (A)
Rec-Lift	599-101	\$299.95
Wheel Kit	599-102	\$72.95

Track Jack

- Heavy duty steel with black powder coating.
- Fits all Polaris models including RMK

Description	Part #	Price (D)
Track-Jack	SM-12271	\$64.95
Max Height = 30"	SM-12274	\$129.95
Max Height = 38"	SM-12274-1	\$109.95

*Freight not included



SM-12274
SM-12274-1



SM-12271

Big Wheel Shop Dolly



Description	Part #	Price* (D)
Shop Dolly - Aluminum Wheels	710-208	\$337.94

*Freight not included



SNO-WHEELS™ Now comes with new Steel/Rubber castors!



SNO14-105



SNO14-104



SNO14-106

Description	Part #	Price (G)
Sno-Wheels Stealth 360 (kit)	SNO14-104	\$59.95
Sno-Wheels Stealth II (plastic base kit)	SNO14-105	\$52.22
Sno-Wheels-UFO (kit)	SNO14-106	\$65.56

Sled Dollies

- Heavy duty steel
- Black finish
- Heavy duty hard rubber casters
- Non-slip rubber strip
- Assembly required – set of 3

Description	Part #	Price (G)
Sled Dollies	SM-12165	\$49.95

- Heavy duty steel
- Powder coated finish
- Wide plastic casters
- Non-slip rubber strip
- Assembly required – set of 3

Description	Part #	Price (G)
Sled Dollies	SM-12221	\$39.95

- Heavy duty steel
- Zinc plated finish
- Nylon wheels
- Extra long ski supports
- Assembly required – set of 3

Description	Part #	Price (G)
Sled Dolly (set)	SM-12220	\$84.95



SM-12165



SM-12221



SM-12220



Torco Snowmobile Oil

Description	Part #	Price (D)
Synth/Petro Snow Oil .946 L (12/cs.)	TOR1L	\$7.95
Synth/Petro Snow Oil 3.784 L (6/cs.)	TOR4L	\$27.49
100% Synthetic Racing Oil 3.784 L (6/cs.)	TOR4LS	\$40.99
100% Synthetic Racing Oil .946 L (12/cs.)	TOR1LS	\$11.99
Chain case 100 Synthetic Oil .473 L (24/cs.)	TOR473	\$10.25
Shock Fluid	TORRSF	\$15.95



Dry Graphite Spray

Provides a long lasting film on parts for extended service. 312 gram spray .

Description	Part #	Price (F)
312 gram spray can	893-555	\$15.95

VP Racing C-5 Octane Booster

New larger 20 ounce bottle V/P Racing fuels available, call for pricing.

Description	Part #	Price (net)
C-5 Octane Booster	V/PC5	\$18.95



Isoflex PTO Bearing Grease



Part #	Price (net)
NB-52	\$42.95



Wynn's Products

Description	Part #	Price (D)
Carburetor/Brake Cleaner – 503 g	60201	\$11.95 ea.
Engine Fogging Oil – 350 g	59801	\$9.95 ea.
Fuel Stabilizer – 325 mL	59601	\$7.95 ea.

Carburetor/Brake Cleaner: Cleans without dismantling. Helps prevent dangerous stalling and rough idling.

Engine Fogging Oil: Protect your investment with the off season fogging oil from Wynn's.

Fuel Stabilizer: Protect your investment from that long summer sit. Stabilizes fuel so you don't have to clean those carbs out in the fall.



Nemco Products

Description	Part #	Price (G)
TC-W3 4-Litre container (4/case)	NEM52004	\$21.95 ea.
Chaincase Oil 350 mL (12/case)	RPM350ML	\$4.25 ea.
150 mL Isopropyl 40/Case	071-150	\$1.65 ea.
350 mL Isopropyl 12/Case	071-350	\$2.45 ea.



Amsoil Products

Description	Part #	Price (D)
Interceptor Synthetic – 3.784 L	AMS4LT1	\$49.95 ea.
Synthetic Chaincase Oil – 355 mL	AMS16206	\$10.95 ea.
Gasoline Stabilizer – 472 mL	AMS16006	\$13.95 ea.
Synthetic Shock Oil Light #5 – 946 mL	AMSSTL01	\$16.95 ea.
HP Injector Synthetic 2-cycle – 3.784 L	AMSHP4L	\$39.95 ea.

Interceptor Synthetic 2-cycle Oil: Excellent exhaust power valve performance.

Synthetic Chaincase Oil: Provides superb cold temperature flow and high temperature stability.

Gasoline Stabilizer: Prevents fuel deterioration during storage, allowing easier start-ups. Suitable for gasoline or diesel fuel.

Shock Therapy Suspension Fluid: Light #5. Contains anti-wear agents that reduce internal wear and contains anti-foaming additives for consistent, smooth dampening. Added seal conditioners keep seals soft and increase their service life.

HP Injector Synthetic 2-cycle Oil: For top performance with DFI, EFI and carbureted fuel systems

Plexus

Plexus seals the pores in plastic surfaces with a micro-thin layer of shiny, protective wax. The plastic becomes resistant to debris, oil, scratches and eventual yellowing. Its anti-static properties repel dust and lint. It leaves no smears or smudges. Plastic makes coloured plastics vibrant, clear plastic virtually transparent and plastic paints gleaming like new.



Description	Part #	Price (D)
13 oz. Spray shop size	216572	\$11.69

Note: May order by the case.
Spray sizes are packaged 12 per case.

Ratio-Rite

Getting the right oil-to-gas ratio is no problem with this polypropylene measuring cup. Ratios from 16:1 to 50:1. 18 oz. capacity.



Description	Part#	Price (F)
Ratio-Rite	HPE959-001	\$10.95



Accu-Mix measuring bottle

Part #	Price (D)
AAA700619	\$4.99



Description	Part #	Price (G)
Silicone Liquid Gasket (-60 to +250C) Forms a rubberized seal to prevent Gas, Water & Oil leaks	TB1211	\$20.95 ea.
Liquid Gasket An excellent Crankcase Sealer for all engines	TB1104	\$6.95 ea.
Hi-Temperature Thread-Lock	TB1360	\$4.50 ea.
Engine Gloss; for the detail conscious owner who wants their engine to shine.	TB6501	\$8.95 ea.
Super Glue; Excellent for non-porous materials. Dries in seconds	TB1742B	\$2.50 ea.
Plastic Repair Kit; Great for repairs on plastic body parts.	TB1743	\$59.95 per kit
Clear Silicone universal	TB1212C	\$17.95 ea.



Description	Size	Part #	Price (D)
Thread Locker Red	6 mL	LOC26200	\$7.95 /tube
Thread Locker Blue	6 mL	LOC24200	\$9.30 /tube
Form-A-Gasket #2 Sealant Tacky, flexible-setting sealant is designed for flexible materials and flanges. Temp. range -65°F to 400°F	80 mL	LOC2BR	\$4.95 /tube
Spray-A-Gasket (High tack)	113 g	LOC99GA	\$6.50 /can
Gasket Remover Quick removal of old gasket, silicone, grease and paint without damaging your cylinder or manifolds	340 g	LOC4MA	\$8.95 /can
Form -A-Gasket (brush on type)	118 mL	LOC471H	\$6.50 /can
Cold Weld Bonding Compound • Withstands heat to 300°F • Drill it, Tap it, File it, Machine it • Thousands of uses	56 g x 2	LOC14600	\$7.90 /tube
Aviation Form -A-Gasket	473 mL	LOC3D	\$11.50 /can
Ultra Copper High Temp RTV Silicone • The most advanced hi-performance, high temperature RTV gasket available. • Temperatures up to 700°F	85 g	LOC101BR	\$10.73 /tube
Ultra Black OEM Hi-temp RTV Silicone • OEM tested to comply with Extended Warranty requirements. Sensor safe • Excellent Adhesion • Non-Corrosive	95 g	LOC598	\$9.95 /tube

Multi-Knives

Description	Part #	Price (G)
Folding Multi-Knife with Pliers	SM-12228	\$19.95
Pocket Multi-Knife	SM-12231	\$9.95



SM-12228

SM-12231

Impact Screwdriver



Description	Part #	Price (G)
Impact Screwdriver	012-2850	\$19.95

Digital Caliper

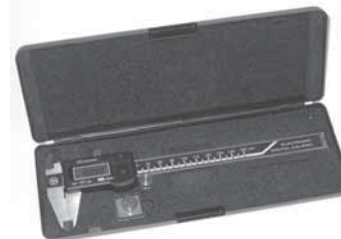

Description	Part #	Price (G)
Digital Caliper	SM-12036	\$69.95

Econokit Metric Tool Kits

- Convenient and easy-to-carry tool kits
- Includes one adjustable wrench, two combination wrenches, hex keys, spark plug socket, 6-in-1 reversible screwdriver, tire gauge, WD-40®, zip ties, shop rag, and yes, even bailing wire
- Comes in heavyweight nylon shell with YKK zippers
- Closed dimensions: 4" L x 9" W x 1½" thick

Description	Part #	Price (D)
Econokit Metric Tool Kit	632100	\$42.95



632100

Econokit Snowmobile Tool Kit

- With this kit, you can tackle problems with your own sled — or almost anyone else's
- Designed for the most common fasteners used on Arctic Cat, Polaris, Ski-Doo and Yamaha sleds
- Contains five combination 10mm, 12mm, 14mm, 1/2" and 9/16" wrenches; and 8" adjustable wrench; 2 hex keys (3/16", 2.50mm) and two Torx® keys (T-20, T-25); a locking pliers; a 13/16" sparkplug socket; and a 6-in-1 reversible screwdriver
- It all goes into a 600 denier Cordura® zippered pouch, which also contains cable ties, mechanic's wire and a shop towel

Description	Part #	Price (D)
Econokit Snowmobile Tool Kit	632102	\$55.95



632102

Fanny Pack Tool Kit

- So complete, you're ready to ride
- Includes wrenches, pliers, hex keys, screwdriver, packWrench™, flashlight, tire levers, tire gauge and more
- Top quality hardware and straps
- Pouch designed to handle heavy trail abuse using 5040 nylon with plenty of extra storage

Description	Part #	Price (D)
Fanny Pack Tool Kit	632101	\$89.95



632101

Econokit Tool Kit

- A general-use kit for a wide variety of non-metric vehicles
- Includes 3/8", 7/16", 1/2" and 9/16" combination wrenches, 8" adjustable wrench, 6-in-1 screwdriver, locking pliers, tire pressure gauge, electrical tape, cable ties, mechanic's wire, thread locker, WD-40®, and shop towel
- Packaged in a coated polyester zip-up

Description	Part #	Price (D)
Econokit Generic Tool Kit	631109	\$49.95



632109

Tool Kits

- Convenient and easy-to-carry tool kits
- Available in standard or deluxe versions
- Deluxe version includes 3/8", 7/16", 1/2", 9/16" and 10mm combination wrenches, 8" adjustable wrench, five hex keys, three TorxR keys, a 6-in-1 reversible screwdriver, 5/8" and 13/16" spark plug sockets, gap gauge, thread locker and a two-AA battery metal-body flashlight with adjustable beam and a spare bulb
- Standard version includes 3/8", 7/16", 1/2", 9/16" and 10mm combination wrenches, five hex keys, three Torx® keys, a 6-in-1 reversible screwdriver, a 2-in-1 sparkplug tool with 5/8" and 13/16" sizes (includes breaker bar), cable ties, mechanics wire, a tire pressure gauge and a shop towel
- Kits come in a coated polyester roll-up style blue pouch

Description	Part #	Price (D)
Econokit Deluxe Tool Kit	631107	\$72.95
Econokit Standard Tool Kit	631108	\$49.95



632108



632107

Clymer Manuals

Clymer and Intertec repair manuals offer complete repair information and are designed for both do-it-yourselfers and professional mechanics. Readers learn the skills that let them save money on maintenance and repair bills and enjoy the satisfaction of working on their own snowmobile.



Every Clymer manual features detailed illustrations and photographs that guide the reader through each job. These titles include information covering troubleshooting, lubrication, maintenance and tune-up, engine overhaul procedures, primary and secondary clutch fundamentals and service, fuel systems, exhaust and emission control systems, electrical systems, front suspension steering, rear suspension and track, brake service and more. Complete wiring diagrams for all models are included.

Carb Tuning Handbook

A completely new and updated Carb Tuning Handbook. This book covers the basics in carb tuning, testing and racing. Mikuni's Roundslide, Flatslide, and new TMX are discussed in detail. A must for the serious rider who wants the most out of their sled. Learn how to diagnose your carb's performance, use correct testing procedures, and calibrate with the proper tools.

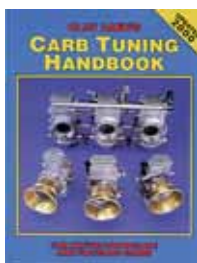

Title	Part #	Price (D)
Carb Tuning Handbook	021-102	\$39.95

Clutch Tuning Handbook

An absolute must for any clutch mechanic. This handy handbook by Olav Aaen includes theory and modification of the Comet, Arctic, Polaris, Skidoo & Yamaha. This handbook is geared to the serious racer or anyone who wants more performance from their snowmobile clutch.

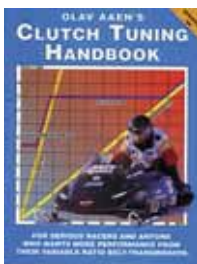

Title	Part #	Price (D)
Clutch Tuning Handbook	021-101	\$34.95

Description	Part #	Price (F)
11th Ed. Service Manual Covers 97 manufacturers and is the only universal repair and maintenance source available for snowmobiles produced through 1986.	SMS11	\$41.95
Vintage Snowmobiles Vol.1 – Arctic Cat 1974-79, John Deere 1972-77, Kawasaki 1976-80	S820	\$41.95
Vintage Snowmobiles Vol.2 – Polaris 1973-79, Ski-Doo 1970-79, Yamaha 1975-80	S821	\$41.95
Arctic Cat – El-Tigre EXT 1988-89, Wildcat 1989	S835	\$41.95
Arctic Cat – 1990-98 Cougar, El Tigre, EXT, Pantera, Panther, Powder Exteme, Powder Special, Powder Special EFI, Prowler, Prowler Mtn. Cat, Z, ZL, ZR, ZRT	S836	\$41.95
Polaris Indy – 1984-89	S832	\$41.95
Polaris Indy – 1990-95	S833	\$41.95
Ski-Doo – Formula MX 1985-89, Formula Plus 1985-89, Mach 1 1989	S829	\$41.95
Ski-Doo – Formula MX, Plus, Mach-1 1990-95	S830	\$41.95
Yamaha – EX 570 1987-89, Phazer 1984-89	S826	\$41.95
Yamaha – Three-Cylinder Models 1997-02 MM600, SX600, VT600, VX600ER, VX600SX, MM700, SX700, VT700, VX700SX, VX700SXS, VX700XT, VX700XTC, VX700XTCD, VX700TCP.	S827	\$41.95

"As the Snow Flies"

This Publication provides the first recorded complete history of early snowmobile development in both Canada and the United States. The time frame is from 1900 to 1960 which is the period pioneering work was done. Small recreational and utility snowmobiles, large track driven snowmobiles, as well as propeller driven snow vehicles are covered. There is a separate chapter for each company or person who produced snowmobiles on a commercial basis during the specified time period. Each chapter includes coverage of the trials and tribulations of the inventors, as well as specifications of the models being developed. Sales brochures and copies of patents are included when available. A bibliography is included at the end of each chapter. The last two chapters provide an engineering and performance analysis of the various designs, as well as a chronological history of the important events in snowmobile development.



Title	Part #	Price (F)
As the Snow Flies	119200	\$94.95

DVD Videos



Title	Part #	Price (net)
2 Stroke Cold Smoke #9	DVD36	\$39.95
2's Better Than 1	DVD99-1	\$34.95
Alticity 6	DVD33	\$39.95
BRAAP 5	DVD26	\$34.95
BRAAP 6	DVD32	\$39.95
Crusty Demons 10	DVD419	\$39.95
J.Quinlan	DVD11	\$39.95
Mountain Mod Mania 4	DVD34	\$39.95
Nitrous Circus 4	DVD39	\$29.95
Roops of Hazzard 7	DVD25	\$34.95
Roops of Hazzard 8	DVD35	\$39.95
Slednecks-8	DVD1	\$39.95
Slednecks-9	DVD30	\$39.95
Superbike 2001	DVD21	\$32.95
Thunderstruck #4	DVD22	\$39.95
Thunderstruck #5	DVD31	\$39.95
Turnagain-4	DVD20	\$37.95