

Chaincase and Sprockets

07

section contents

<i>Chaincases and Covers – Polaris ..</i>	<i>155</i>
<i>Chaincase Bearings and Seals</i>	<i>150</i>
<i>Chaincase Gaskets</i>	<i>154</i>
<i>Chaincase Sprockets</i>	<i>164</i>
<i>Chain Links</i>	<i>153</i>
<i>Chain Tensioner</i>	<i>155</i>
<i>Drive Chains</i>	<i>162</i>
<i>Front Axels – Polaris</i>	<i>156</i>
<i>Jackshafts – Polaris</i>	<i>156</i>

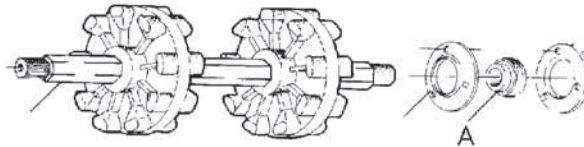
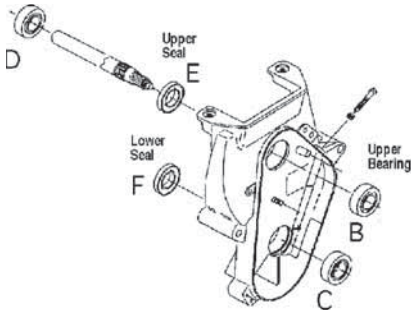

Model	Year	A L.H. Axle Bearing	B Chaincase Upper Bearing #	C Chaincase Lower Bearing #	D L.H. Jackshaft Bearing #	E Upper Seal	F Lower Seal
Arctic Cat							
All Models (except Kitty Cat)	1980-01	004-160-1	004-169	004-160-1	004-169-1	003-1711	003-1711
Polaris							
340 LC, 500 LC Indy	1980-83	004-160-4	004-156	004-156	004-160-4	-	-
400 Indy	1984-86	004-160-4	004-156	004-156	004-160-4	-	-
400 Indy	1987-91	004-160-4	004-156	004-156	004-160-4	003-108	003-108
440 & 488 Trail Indy	1983-86	004-160-4	004-156	004-156	004-160-4	-	-
440 Supersport	1994-96	004-160-4	004-156	004-156	004-160-4	003-108	003-108
440 XCF	1997	004-160-4	004-156	004-156	004-160-4	003-108	003-108
440 XCF	1998-99	004-160-5	004-156	004-156	004-160-5	003-108	003-108
440 XCR	1991-97	004-160-4	004-156	004-156	004-160-4	003-108	003-108
440 XCR	1998-99	004-160-5	004-156	004-156	004-160-4	003-108	003-108
488 Supersport	1997	004-160-4	004-156	004-156	004-160-4	003-108	003-108
488 Supersport	1998	004-160-5	004-156	004-156	004-160-5	003-108	003-108
488 Trail Indy	1987-97	004-160-4	004-156	004-156	004-160-4	003-108	003-108
488 Trail Indy	1998	004-160-5	004-156	004-156	004-160-5	003-108	003-108
500 Carb Indy	1989-92	004-160-4	004-156	004-156	004-160-4	003-108	003-108
500 Carb Indy	1994-97	004-160-4	004-156	004-156	004-160-4	003-108	003-108
500 Carb Indy	1998-00	004-160-5	004-156	004-156	004-160-5	003-108	003-108
500 EFI Indy	1993-97	004-160-4	004-156	004-156	004-160-4	003-108	003-108
500 RMK	2000	004-160-5	004-156	004-156	004-160-5	003-108	003-108
500 Indy,Classic	2000	004-160-5	004-156	004-156	004-160-5	003-108	003-108
500 XC,XC-SP,VES	1999-00	004-160-5	004-156	004-156	004-160-5	003-108	003-108
550 Supersport	1999-00	004-160-5	004-156	004-156	004-160-5	003-108	003-108
580 XLT	1993-94	004-160-4	004-156	004-156	004-160-4	003-108	003-108
600 Indy	1983-86	004-160-4	004-156	004-156	004-160-4	-	-
600 Indy	1987	004-160-4	004-156	004-156	004-160-4	003-108	003-108
600 RMK, Triumph	2000	004-160-5	004-156	004-156	004-160-5	003-108	003-108
600 XCR Triple Pipe	1996	004-160-5	004-156	004-156	004-160-4	003-108	003-108
600 XCR Triple Pipe	1997-98	004-160-5	004-156	004-156	004-160-5	003-108	003-108
600 XC	1997	004-160-4	004-156	004-156	004-160-4	003-108	003-108
600 XC,XC-SP,RMK	1998-99	004-160-5	004-156	004-156	004-160-5	003-108	003-108
600 XCR	1994-96	004-160-4	004-156	004-156	004-160-4	003-108	003-108
600 XC-SP	2000	004-160-5	004-156	004-156	004-160-5	003-108	003-108
600 XLT	1995-97	004-160-4	004-156	004-156	004-160-4	003-108	003-108
600 XLT-LTD	1998	004-160-5	004-156	004-156	004-160-5	003-108	003-108
600 XLT-SP/Classic	1998-99	004-160-5	004-156	004-156	004-160-5	003-108	003-108
600 XLT-SP/LTD	1997	004-160-4	004-156	004-156	004-160-4	003-108	003-108
650 Indy	1988-91	004-160-4	004-156	004-156	004-160-4	003-108	003-108
650 RXL	1991-97	004-160-4	004-156	004-156	004-160-4	003-108	003-108
680 Ultra	1998	004-160-5	004-156	004-156	004-160-5	003-108	003-108
680 Ultra, Ultra-SPX	1996-97	004-160-5	004-156	004-156	004-160-4	003-108	003-108
700 XC, XC-SP, RMK	1997	004-160-4	004-156	004-156	004-160-4	003-108	003-108
700 XC, XC-SP, RMK	1998-01	004-160-5	004-156	004-156	004-160-5	003-108	003-108
700 XCR	1998-99	004-160-5	004-156	004-156	004-160-5	003-108	003-108
750 Storm	1993	004-160-4	004-156	004-156	004-160-4	003-108	003-108
800 Storm	1994-95	004-160-4	004-156	004-156	004-160-4	003-108	003-108
800 Storm	1996-97	004-160-5	004-156	004-156	004-160-4	003-108	003-108
800 Storm	1998-00	004-160-5	004-156	004-156	004-160-5	003-108	003-108
800 XCR	1998-01	004-160-5	004-156	004-156	004-160-5	003-108	003-108
Ski-Doo							
Formula Dlx-670,583,500	1999	004-160-6	004-156	004-165	004-160-1	003-107-3	003-107
Formula III	1995-96	004-156	004-156	004-165	004-160-1	003-107-1	003-107
Formula III 600,700	1998	004-160-6	004-156	004-165	004-160-1	003-107-4	003-107
Formula III 600,700,800	1999	004-160-6	004-156	004-165	004-160-1	003-107-3	003-107
Formula III, III-LT	1997	004-156	004-156	004-165	004-160-1	003-107-1	003-107

Chain Case Seals

Part #	Price (G)
003-106	\$2.25
003-106-2	\$4.15
003-106-5	\$3.95
003-107	\$4.99
003-107-1	\$4.50
003-107-2	\$8.95
003-107-3	\$14.95
003-107-4	\$8.50
003-108	\$3.95
003-110	\$2.50
003-110-2	\$2.95
003-110-5	\$5.95
003-110-6	\$5.95

Chain Case Bearings

Part #	Price (G)
004-152	\$4.60
004-152-1	\$4.95
004-152-2	\$4.95
004-152-3	\$12.95
004-152-4	\$4.95
004-152-5	\$16.95
004-153	\$4.95
004-156	\$4.95
004-156-1	\$27.95
004-156-2	\$27.62
004-156-3	\$26.95
004-157	\$5.95
004-160-1	\$10.95
004-160-2	\$3.15
004-160-3	\$22.95
004-160-4	\$10.95
004-160-5	\$24.95
004-160-6	\$15.95
004-160-7	\$22.95
004-160-8	\$19.95
004-161	\$4.59
004-162	\$2.95
004-163	\$4.95
004-163-1	\$4.95
004-164	\$21.95
004-165	\$12.95
004-165-1	\$3.05
004-166	\$9.95
004-167	\$9.95
004-168	\$5.95
004-169	\$19.95
004-169-1	\$19.95
004-169-2	\$18.75

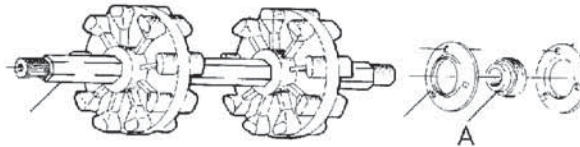
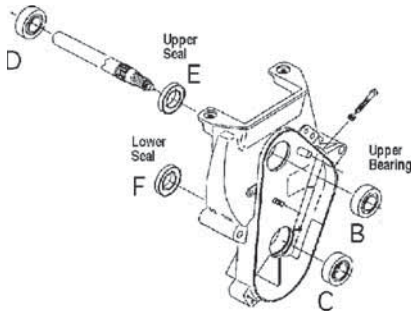

Model	Year	A L.H. Axle Bearing	B Chaincase Upper Bearing #	C Chaincase Lower Bearing #	D L.H. Jackshaft Bearing #	E Upper Seal	F Lower Seal
Formula MX, Plus	1987-88	004-156	004-156	004-164	004-160-1	003-107-1	003-107
Formula MX, Plus, Mach-1	1989-92	004-156	004-156	004-164	004-160-1	003-107-1	003-107
Formula MXZ, Mach-Z, Mach-1	1993	004-156	004-156	004-165	004-160-1	003-107-1	003-107
Formula MX, Plus	1994	004-156	004-156	004-165	004-160-1	003-107-1	003-107
Formula MX, MXZ	1995	004-156	004-156	004-165	004-160-1	003-107-1	003-107
Formula SE	1998	004-156	004-156	004-156	004-160-1	003-107-3	003-106
Formula S,SL	1995-98	004-156	004-156	004-156	004-160-1	003-107-3	003-106
Formula S,SL	1999	004-160-6	004-156	004-156	004-160-1	003-107-3	003-106
Formula SLS	1996	004-156	004-156	004-165	004-160-1	003-107-3	003-107
Formula STX, ST	1994	004-156	004-156	004-165	004-160-1	003-107-1	003-107
Formula STX, STX-LT	1996	004-156	004-156	004-165	004-160-1	003-107-3	003-107
Formula XTC,EFI	1992-93	004-156	004-156	004-165	004-160-1	003-107-1	003-107
Formula Z 583, 500, 500Dlx	1997	004-156	004-156	004-165	004-160-1	003-107-3	003-107
Formula Z, Formula SS	1996	004-156	004-156	004-156	004-160-1	003-107-1	003-107
Formula Z, STX, SS	1995	004-156	004-156	004-165	004-160-1	003-107-1	003-107
Formula Z 500/583 & Deluxe	1998	004-156	004-156	004-165	004-160-1	003-107-3	003-107
Formula Z 670	1998	004-156	004-156	004-165	004-160-1	003-107-1	003-107
Formula Z 670,583,500	1999	004-160-6	004-156	004-165	004-160-1	003-107-3	003-107
Grand Touring 580,500	1996	004-156	004-156	004-165	004-160-1	003-107-3	003-107
Grand Touring 583,500	1998	004-156	004-156	004-165	004-160-1	003-107-3	003-107
Grand Touring 583,500	1999	004-160-6	004-156	004-165	004-160-1	003-107-3	003-107
Grand Touring SE	1996	004-156	004-156	004-156	004-160-1	003-107-1	003-107
Grand Touring SE,580,470	1995	004-156	004-156	004-165	004-160-1	003-107-1	003-107
Grand Touring SE,700	1998-99	004-160-6	004-156	004-165	004-160-1	003-107-4	003-107
Grand Touring SE,700,583,500	1997	004-156	004-156	004-165	004-160-1	003-107-3	003-107
Grand Touring SE,XTC	1994	004-156	004-156	004-165	004-160-1	003-107-1	003-107
Mach-1,GT	1994	004-156	004-156	004-165	004-160-1	003-107-1	003-107
Mach-Z, Mach-1	1994-97	004-156	004-156	004-165	004-160-1	003-107-1	003-107
Mach-Z, Mach-1	1998-99	004-160-6	004-156	004-165	004-160-1	003-107-4	003-107
MXZ 440	1996	004-156	004-156	004-165	004-160-1	003-107-1	003-107
MXZ 440LC	1997	004-156	004-156	004-165	004-160-1	003-107-1	003-107
MXZ 440F	1997-98	004-156	004-156	004-156	004-160-1	003-107-3	003-106
MXZ 440	1999	004-160-6	004-156	004-156	004-160-1	003-107-3	003-106
MXZ 500	1998	004-156	004-156	004-165	004-160-1	003-107-1	003-107
MXZ 500/670	1999	004-160-6	004-156	004-165	004-160-1	003-107-1	003-107
MXZ 500	2000	004-160-6	004-156	004-160-7	004-160-1	003-107-2	-
MXZ 600,700	2000	004-160-6	004-156	004-160-7	004-160-5	003-107-2	-
MXZ 670,583	1996-98	004-156	004-156	004-165	004-160-1	003-107-1	003-107
MXZ 700	1999	004-160-6	004-156	004-160-7	004-160-1	003-107-4	-
MXZX 440	2000	004-160-6	004-156	004-160-7	004-160-1	003-107-2	-
MXZX 440LC	1997	004-156	004-156	004-160-7	004-160-1	n/a	-
MXZX 440LC	1998	004-156	004-156	004-160-7	004-160-1	003-107-1	-
Skandic 380	1999	004-160-6	004-156	004-156	004-160-5	003-107-3	003-106
Skandic 500,380	1995-98	004-156	004-156	004-156	004-160-1	003-107-3	003-106
Summit 470	1994	004-156	004-156	004-165	004-160-1	003-107-1	003-107
Summit 500	1996-98	004-156	004-156	004-165	004-160-1	003-107-3	003-107
Summit 583	1994-95	004-156	004-156	004-165	004-160-1	003-107-1	003-107
Summit 583	1996-98	004-156	004-156	004-165	004-160-1	003-107-3	003-107
Summit 600	1999	004-160-6	004-156	004-160-7	004-160-1	003-107-4	-
Summit 670	1995-96	004-156	004-156	004-165	004-160-1	003-107-1	003-107
Summit 670	1997	004-156	004-156	004-165	004-160-1	003-107-3	003-107
Summit 670,670X	1998	004-156	004-156	004-165	004-160-1	003-107-1	003-107
Touring E,LE	1995-98	004-156	004-156	004-156	004-160-1	003-107-3	003-106
Touring E,LE	1999	004-156	004-156	004-156	004-160-5	003-107-3	003-106
Touring SLE	1995-97	004-156	004-156	004-156	004-160-1	003-107-3	003-106
Touring SLE	1998-99	004-156	004-156	004-156	004-160-5	003-107-3	003-106

Chain Case Seals

Part #	Price (G)
003-106	\$2.25
003-106-2	\$4.15
003-106-5	\$3.95
003-107	\$4.99
003-107-1	\$4.50
003-107-2	\$8.95
003-107-3	\$14.95
003-107-4	\$8.50
003-108	\$3.95
003-110	\$2.50
003-110-2	\$2.95
003-110-5	\$5.95
003-110-6	\$5.95

Chain Case Bearings

Part #	Price (G)
004-152	\$4.60
004-152-1	\$4.95
004-152-2	\$4.95
004-152-3	\$12.95
004-152-4	\$4.95
004-152-5	\$16.95
004-153	\$4.95
004-156	\$4.95
004-156-1	\$27.95
004-156-2	\$27.62
004-156-3	\$26.95
004-157	\$5.95
004-160-1	\$10.95
004-160-2	\$3.15
004-160-3	\$22.95
004-160-4	\$10.95
004-160-5	\$24.95
004-160-6	\$15.95
004-160-7	\$22.95
004-160-8	\$19.95
004-161	\$4.59
004-162	\$2.95
004-163	\$4.95
004-163-1	\$4.95
004-164	\$21.95
004-165	\$12.95
004-165-1	\$3.05
004-166	\$9.95
004-167	\$9.95
004-168	\$5.95
004-169	\$19.95
004-169-1	\$19.95
004-169-2	\$18.75

Model	Year	A L.H. Axle Bearing	B Chaincase Upper Bearing #	C Chaincase Lower Bearing #	D L.H. Jackshaft Bearing #	E Upper Seal	F Lower Seal
Yamaha							
Bravo's	1982-00	004-152-1	004-152-2	004-152-2	-	003-110-6	-
ET250,300,340,400	1977-92	004-152-1	-	-	-	-	-
Exciter 570	1987-93	004-152-3	004-156	004-156	004-156-1	-	003-110-6
Mountain Max 600,700	1997-00	004-156-3	004-156	004-156	004-160-8	003-110-5	003-110-5
Mountain SRX 700	1998	004-156-3	004-156	004-156	004-160-8	003-110-5	003-110-5
Ovation	1989-94	004-152-3	004-156	004-156	004-156-1	-	003-110-6
Phazer Mountain Lite	1997	004-152-3	004-156	004-156	004-156-1	-	003-110-6
Phazer's	2000-01	004-156-3	004-156	004-156	004-160-4	003-110-5	003-110-5
Phazer's	1984-99	004-152-3	004-156	004-156	004-156-1	-	003-110-6
SRV's	1980-91	004-152-3	004-156	004-156	004-156-2	-	003-110-6
SRX 600,700	1998-99	004-156-3	004-156	004-156	004-160-8	003-110-5	003-110-5
SRX 700	2000	004-156-3	004-156	004-156	004-160-8	003-110-5	003-110-5
Venture 500,600	1997-98	004-156-3	004-156	004-156	004-160-8	003-110-5	003-110-5
Venture VT500,600,700	1999-00	004-156-3	004-156	004-156	004-160-8	003-110-5	003-110-5
V-Max 500,600,700	1997	004-156-3	004-156	004-156	004-160-8	003-110-5	003-110-5
V-Max 500-600	1992-93	004-152-3	004-152-2	004-156	-	-	-
V-Max 500-600	1994-96	004-152-1	004-156	004-156	004-156	003-110-6	003-110-6
V-Max 500SX,600SX,700SX	1999	004-156-3	004-156	004-156	004-160-8	003-110-5	003-110-5
V-Max 500SX-R,600SX-R,700SX-R	2000	004-156-3	004-156	004-156	004-160-8	003-110-5	003-110-5
V-Max 500XT,600XT	1998	004-156-3	004-156	004-156	004-160-8	003-110-5	003-110-5
V-Max 500XTC,600XTC	1998	004-156-3	004-156	004-156	004-160-8	003-110-5	003-110-5
V-Max 540	1983-91	004-152-3	004-156	004-156	004-156-2	-	-
V-Max 700SX,XTC	1998	004-156-3	004-156	004-156	004-160-8	003-110-5	003-110-5
V-Max-4	1995-97	004-152-5	-	-	-	003-110-5	003-110-6

Chain Case Seals

Part #	Price (G)
003-106	\$2.25
003-106-2	\$4.15
003-106-5	\$3.95
003-107	\$4.99
003-107-1	\$4.50
003-107-2	\$8.95
003-107-3	\$14.95
003-107-4	\$8.50
003-107-5	TBA
003-108	\$3.95
003-110	\$2.50
003-110-2	\$2.95
003-110-5	\$5.95
003-110-6	\$5.95

Chain Case Bearings

Part #	Price (G)
004-152	\$4.60
004-152-1	\$4.95
004-152-2	\$4.95
004-152-3	\$12.95
004-152-4	\$4.95
004-152-5	\$16.95
004-153	\$4.95
004-156	\$4.95
004-156-1	\$27.95
004-156-2	\$27.62
004-156-3	\$26.95
004-157	\$5.95
004-160-1	\$10.95
004-160-2	\$3.15
004-160-3	\$22.95
004-160-4	\$10.95
004-160-5	\$24.95
004-160-6	\$15.95
004-160-7	\$22.95
004-160-8	\$19.95
004-161	\$4.59
004-162	\$2.95
004-163	\$4.95
004-163-1	\$4.95
004-164	\$21.95
004-165	\$12.95
004-165-1	\$3.05
004-166	\$9.95
004-167	\$9.95
004-168	\$5.95
004-169	\$19.95
004-169-1	\$19.95
004-169-2	\$18.75

Chaincase Bearings

Bearing	Inside Dia.	Outside Dia.	Width/mm	Part #	Price (G)	Description
*6201-1RS	12	32	10	004-152	\$4.60	1-seal
*6004-2RS	20	42	12	004-152-1	\$4.95	
*6004-2RS	20	42	12	NTN152-1	\$12.50	NTN Bearing
*6304-2RS	20	52	15	004-152-2	\$4.95	
*60/22-2RS	22	44	12	004-152-3	\$12.95	
*60/22-no seals	22	44	12	004-152-3A	\$12.95	no seals
*6204-2RS	20	47	14	004-152-4	\$4.95	
*6204-2RS	20	47	14	NTN152-4	\$9.25	NTN Bearing
*62/22-2RS	22	50	14	004-152-5	\$16.95	
*6203-2RS	17	40	12	004-153	\$4.95	
86205-2RS	25	52	15	004-156	\$4.95	
*6205-1RS	25	52	15	NTN156	\$7.95	NTN Bearing
*AELS205V-5 2RS	25	52	15/21/37	004-156-1	\$27.95	Flat outer race w/locking collar & set screw
*AELS205V-6 2RS	25	52	15/21/31	004-156-2	\$27.62	Flat outer race w/locking collar & set screw
*ASS205-100N 2RS	25.4	52	15/27	004-156-3	\$26.95	Flat outer race w/collar & 2-set screws
*6205-2RS 1"	25.4	52	15	004-157	\$5.95	
*RA100-Dome 2RS	25.4	52	15/21/31	004-160-1	\$10.95	Domed outer race w/locking collar & set screw
*RA100-Dome 2RS	25.4	52	15//21/31	NTN160-1	\$16.95	Domed outer race w/locking collar & set screw
*SA205-19-2RS	30	62	15/24/36	004-160-3	\$22.95	Domed outer race w/locking collar & set screw
*SB205-16-2RS	25.4	52	15/27	004-160-4	\$10.95	Domed outer race w/collar & 2-set screws
*SB205-16-2RS	25.4	52	15/27	NTN160-4	\$16.95	Domed outer race w/collar & 2-set screws
*CS205-100LLU 2RS	25.4	52	15	004-160-5	\$24.95	
*CS205-LU 1RS	25	52	15	004-160-6	\$15.95	1-seal
*62/28DDU-AV-2RS	28	58	16	004-160-7	\$22.95	
*BU205-2RS	25	52	15/	004-160-8	\$19.95	
*99502H-2RS	.625"	35	11	004-163	\$4.95	
*6202-2RS	15	35	11	004-163-1	\$4.95	
*176205-100	25	52	15/21/31	004-164	\$21.95	
*6206	30	62	16	004-165	\$12.95	no seals
*62/28A-2RS	28.6	52	15	004-166	\$9.95	
*6006-2RS	30	55	13	004-167	\$9.95	
*UD204-2RS	20	47	14	004-168	\$5.95	Domed outer race
*AL205-014	22	52	15/21/31	004-169	\$19.95	Domed outer race w/locking collar & set screw
*UL205-100 Dome	25.4	52	18/35/44	004-169-1	\$19.95	Domed outer race w/wide locking collar & set screw
*AS205-014	22	52	15/27	004-169-2	\$18.75	Domed outer race w/collar & 2-set screws

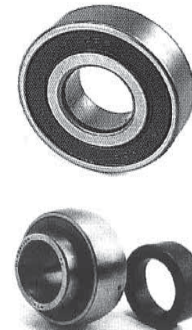

1RS = Single rubber seal

2RS = Double rubber seal

Part # 003-127 #35-2, Double chain
\$2.25



Part # 003-129 #315-2, Double 3/8" Pitch
\$2.65

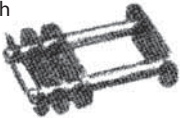

Part # 003-131 #40 Single chain
\$1.95



Part # 003-128 #35-3, Triple chain
\$3.25

Part # 003-129-1 #315-3, Triple chain, 3/8" Pitch
\$3.95

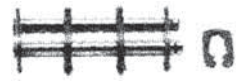

Part # 003-132 #428 Single chain, 1/2" Pitch
\$1.95



Part # 003-133 #40 Single chain
\$2.75

Part #003-134 #428 Single chain, 1/2" Pitch
\$2.95

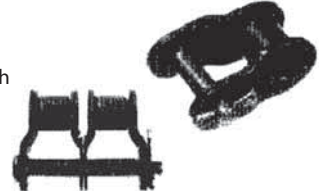

Part # 003-135 #35-2 Double chain, 3/8" PITCH
\$3.95 SKI-D00 412.6008.00

Part # 003-136 #35-2 Double chain
\$4.93 A-Cat*Boa Ski*J-Deere*Kaw*Sno-Jet*Polaris*Rupp*etc

Part # 003-135-1 #315-3 Triple Off Set Link 3/8" Pitch
\$4.95 Ski Roule

Part # 003-135-2 #315-3 Triple Off Set Link
\$6.95 Ski-Doo, Moto-Ski



Part # 003-110-2 Chain Case Seal
\$2.95

Moto Ski 406.3007.00
'79-'81 Grand Prix Special
'80-'82 Futura 500,L/C
'80-'81 Super Sonic
'80-'82 Ultra Sonic

Ski Doo 406.3007.00
'79 Blizzard 5500,9500
'80 Blizzard 5500,7500,9500
'80-'83 Everest 500,L/C
'81 Blizzard 5500,7500,9500
'82 Blizzard 9500,MX 5500
'83-'84 Blizzard 9700,MX



Part # 003-106 **Moto-Ski** 581.1017.00 23 X 54 X 9
\$2.25 **Ski-Doo** 581.1017.00

Chain case bottom seal
Moto-Ski '75-'85
Ski- Doo '63-'89 (front axle)
Rear axle seal
Ski-Doo '60-'88



Part # 003-106-2 **Ski roule** 2041.0007
\$4.15 **Front Axle**
'72-'76 All models



Price # 003-106-5 **Ski-Doo, Moto-Ski** 406.3004.00
\$3.95 **For chain case '76-'83 Spirit 250**
Chain case
'72-'96 Elan 250
'72 Nordic 440
'72-'73 Skandic
'72-'74 Olympique 300,340,400,440



Part # 003-110-3 **Yamaha 93102-25081-00**
\$2.95 **For chain case**
'74-'97 All models
'98-'02 Bravo 250
'98-'01 Ovation 340
'98-'01 Phazer 480



Part #003-110 **Ski-Doo, Moto-Ski**
\$2.50 406.3005.00 use 406.3006.00
For chain case '72-'98



Part # P3610030 Polaris Chain case seal
\$10.95 (upper and lower)
'93-'02 all models Indy



Part # 003-110-5 **Yamaha 93102-35318-00**
\$5.95 **35 X 47 X 7mm**
Lower chain case seal
'94-'99 Most models



Chain Case Gaskets and O-Rings for Arctic Cat

Model	Year	Gasket		Bearing O-Ring	
		Part #	Price	Part #	Price
Cheetah	1972-73	003-1710	\$3.95	003-1712	\$1.50
Cheetah	1974-78	003-1708	\$3.95	003-1711	\$1.50
Cross Country	1976-77	003-1707	\$3.95	003-1711	\$1.50
Cross Country	1978-79	003-1707	\$3.95		
EXT	1971	003-1707	\$3.95	003-1711	\$1.50
El Tigre	1973-84	003-1707	\$3.95	003-1711	\$1.50
Jag	1975-81	003-1707	\$3.95	003-1711	\$1.50
Lynx	1971-74	003-1710	\$3.95	003-1712	\$1.50
Lynx	1977-80	003-1709	\$3.95	003-1711	\$1.50
Pantera,Puma	1970-73	003-1710	\$3.95	003-1712	\$1.50
Pantera	1975	003-1708	\$3.95		
Pantera	1976-81	003-1707	\$3.95	003-1711	\$1.50
Panther	1974	003-1708	\$3.95	003-1712	\$1.50
Panther	1975-79	003-1708	\$3.95	003-1711	\$1.50
Panther	1980-84	003-1707	\$3.95	003-1711	\$1.50

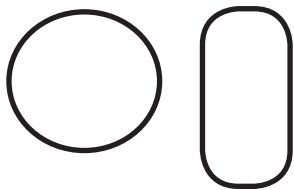

Description	Part #	Price (G)
Polaris Chaincase Gasket oem#5411207, 5410277	003-207	\$5.95



Fits:	Model	Year	Model	Year
	All Indy & TXL	1980-91	Trail Indy, Trail-RMK	1985-97
	Classic 500	1988-97	Trail RMK	1999-03
	Classic Touring	1993-97	Trail Deluxe	1988-95
	Indy 400,400SKS	1985-91	Trail Touring	1996-97
	Indy 440 L/C	1992-97	Transport	1996-97
	Indy 440XCR	1992-95	Ultra 680 (all)	1996-97
	Indy 500,500SKS,EFI	1989-97	XC-400	1991
	Indy 500 Classic	1991-92	XLT's (all)	1993-97
	Indy 600	1985-87	440-XC	1997
	Indy 650,RXL	1988-94	440 XCR	1994-99
	Lite, Lite Deluxe	1993-97	500 XC,XCSP	1999-00
	Lite-GT	1991-97	500 RMK	2000-02
	Longtrack	1985-88	600-XC,XCSP	1997-00
	RXL, RXL Touring	1990-97	600 XC Deluxe	2000
	Sport Indy,Sport-GT	1987-97	600 RMK	1998-01
	Sport Touring	1995-03	600 XCR	1994-97
	Sprint	1990	600 XCR-SP	1996
	Star	1990-	700 Classic	2001
	Starlite	1994-95	700 XC,XCSP	1997-00
	StarLite GT, Star-GT	1993-96	700 RMK	1997-01
	Star Track	1987-90	700 SKS	1997-02
	Storm (all)	1993-97	800 XCR	2000-03
	Supersport	1994-97	800 RMK	2000-01

Polaris Chain Case Gaskets

Description	Part #	Price
Chain Case Gasket O-ring style	P5411497	\$6.95

Fits Model	Year
800 XCSP	2002-03
800 RMK 151"/156"	2002-03
800 Classic Tour. , SKS	2003
700 XC Sp (Ves), RMK, Classic	2002-03
700 Classic, Classic Tour. ,SKS	2003
600 XCSP, Pro X, Classic, RMK	2001-03
600 Classic	2003
550 Super Sport-Edge, Classic	2002-03
550 Classic	2003
500 XCSP	2001-03
500 Classic	2003
440 Pro X, Pro X Fan	2002-03
440 XCR-SP	1999
440 XCSP	2000



Yamaha Chain Case Gaskets

Model	Year	OEM #	Part #	Price (D)
Bravo	1986-99	86A-47592-00	003-160	\$4.95
CF 300	1986-90	86E-47592-00	003-160-1	\$0.95
CS 340E	1992-00	86M-47592-00	003-160-4	\$8.95
Exciter 570	1992-93	8L9-47592-00	003-160-7	\$8.95
Phazer	1984-00	86M-47592-00	003-160-4	\$8.95
SRV 540	1981-88	8L9-47592-00	003-160-7	\$8.95
SSR 440	1978	878-47544-00	003-160-5	\$5.25
XL 540	1989	86K-47592-00	003-160-8	\$1.15
VK 540	1988-97	85R-47544-00	003-160-9	\$1.50
VMX 540	1983-90	8L9-47592-00	003-160-7	\$8.95

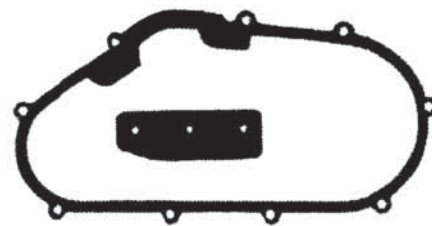

Polaris Chaincases & Covers

Model	Year	Chaincase		Cover	
		Part #	Price (D)	Part #	Price (D)
800 XC SP	2004			P5631354	\$99.95
800 Vertical Escape	2003			P5631354	\$99.95
800 Switchback	2004			P5631354	\$99.95
800 RMK (all)	2004			P5631354	\$99.95
800 Pro X/X2/XR	2003-04			P5631354	\$99.95
800 Classic/Touring	2004			P5631354	\$99.95
800 Classic Touring	2003			P5631354	\$99.95
700 XC SP	2004			P5631354	\$99.95
700 Switchback	2004			P5631354	\$99.95
700 RMK (all)	2004			P5631354	\$99.95
700 Pro X/X2	2003-04			P5631354	\$99.95
700 Classic/Touring	2004			P5631354	\$99.95
700 Classic Touring	2003			P5631354	\$99.95
700 Classic	2001	P5131455	\$219.95	P5131454	\$110.99
650 RXL/Carb	1991-92	P5130795	\$99.95	P5222579	\$49.95
650 Carb	1988-90	P1332124	\$229.95	P5222579	\$49.95
600 XC SP	2004			P5631354	\$99.95
600 Touring/Switchback	2004			P5631354	\$99.95
600 RMK (all)	2004			P5631354	\$99.95
600 Pro X/X2	2003-04			P5631354	\$99.95
600 Indy	1985-87	P1332124	\$229.95	P5222579	\$49.95
600 Classic	2004			P5631354	\$99.95
550 Trail Touring	2004			P5631354	\$99.95
550 Trail RMK 136"	2004			P5631354	\$99.95
550 Super Sport	2004			P5631354	\$99.95
550 Sport Touring	2004			P5631354	\$99.95
550 Sport Touring	2003			P5131454	\$110.99
550 Pro X/Classic	2004			P5631354	\$99.95
500 XC SP	2004			P5631354	\$99.95
500 Indy Carb	2004			P5631354	\$99.95
500 EFI/Carb	1991-92	P5130795	\$99.95	P5222579	\$49.95
500 EFI/Carb	1989-90	P1332124	\$229.95	P5222579	\$49.95
488 Trail	1992	P5130795	\$99.95		
488 Trail	1989-91	P1332124	\$229.95	P5222579	\$49.95
440 XCR	1991-92	P5130795	\$99.95		
440 XCF	1997	P5130795	\$99.95		
440 Supersport	1991-92	P5130795	\$99.95		
440 Pro-X, Pro-X Fan	2003	P5134085	\$119.95	P5631354	\$99.95
440 Pro XR	2004	P5134260	TBA	P5631354	\$99.95

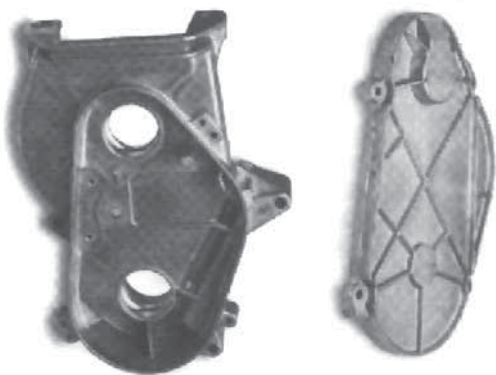

Part # 003-297 ARCTIC CAT 0107-228
\$2.25 (G) (small) Tensioner block '73-'96

Part # 003-298 ARCTIC CAT 0107-411
\$2.25 (G) (large) Tensioner block

Chain Tensioner for Arctic Cat

Model	Year	OEM #	Part #	Price (G)
Arctic Cat (all)	1988-91	0636-514	SM-03093	\$25.95
Arctic Cat (all)	1996-97	0639-431	SM-03092	\$25.95



Chain Tensioner for Polaris

Model	Year	Part #	Price
All Indy	1976-95	003-102-12	\$21.95 (G)
All (except below)	1976-03	P1332213	\$88.95 (net)
700/800 Classic Tour.	2003		
Vert.Escape	2003		
440/600/700/800 Pro-X	2003		
440 Pro-X Fan	2003		
440 Pro-X / Pro-X Fan	2002		
440 Pro-X	2001		



Part # 003-102-8 Chain Tensioner Spring
\$0.50 (G) **Ski- Doo** 414.1306.00

'76-'85 Moto Ski models
 '71-'97 Ski Doo models



Part # 003-102-4 Chain Tensioner
\$4.50 (G) '76-'85 **Moto Ski** 572.0408.00
 '72-'91 **Ski- Doo** 414.0985.00 use 572.0408.00



Part # 003-102-9 Chain Tensioner
\$5.50 (G) **Polaris** 1332070,13:

'72-'83 Apollo*Colt,SS*Gemini*SS 340



Part # 003-102-10 Chain Tensioner
\$6.25 (G) **Yamaha** 8F3-47611-01-00

'77-'84 ET 250, 300
 '83-'95 Bravo 250
 '85-'89 CF300



Part # 003-102-11 Chain Tensioner
\$10.50 (G) **Yamaha** 868-47611-00

'76-'88 ET 340
 '82-'88 ET 340T
 '81-'88 Excel III
 '89-'91 ET 400





Axle Assembly with Sprockets

Discontinued. *While supplies last.*

Model	Year	Part #	#Sp.	Price (D)
650 RXL	1992	P1590225	4	\$289.95
650 Carb	1991-92	P1590225	4	\$289.95

Front Axle Only and Jackshaft

Discontinued. *While supplies last.*

Model	Year	Front Axle Only		Jackshaft	
		Part #	Price (D)	Part #	Price (D)
800 Storm	1994-95	P6230130	\$186.02		
750 Storm	1993	P6230130	\$186.02	P1332148-093	\$169.95
700XC	1997			P2201118	\$189.95
Ultra 680	1998			P1332208	\$179.95
Ultra 680	1997			P2201118	\$189.95
Ultra 680	1996			P1332179-067	\$239.95
650 RXL	1996	P6230130	\$186.02	P2201118	\$189.95
650 RXL	1993-95	P6230130	\$186.02		
650 RXL	1991-92			P1332135-067	\$244.95
650 Carb	1992			P1332135-067	\$244.95
600 SP/600XCR (triple pipe)	1996			P1332179-067	\$239.95
600 XC triple	1997	P6230130	\$186.02	P2201118	\$189.95
600 XCR	1994-96	P6230130	\$186.02		
600 XLT-SP	1998-99			P1332207	\$179.95
600 Ltd, Classic	1998			P1332207	\$179.95
600 XLT Std	1997	P6230130	\$186.02	P2201118	\$189.95
600 XLT	1996	P6230130	\$186.02	P2201118	\$189.95
580/600 XLT	1993-95	P6230130	\$186.02		
500 EFI	1997	P6230130	\$186.02	P2201118	\$189.95
500 EFI	1993-96	P6230130	\$186.02		
500 Carb	1997	P6230130	\$186.02	P2201118	\$189.95
500 Carb	1995-96	P6230130	\$186.02		
500 Carb	1992	P6230130	\$186.02	P1332135-067	\$244.95
488 Supersport	1997	P6230130	\$186.02	P2201118	\$189.95
440 XCR-SP	1996	P6230130	\$186.02	P1332165-067	\$199.95
440 XCR-SP	1994-95	P6230130	\$186.02		
440 XC	1997	P6230130	\$186.02	P2201118	\$189.95
440 XCR	1993-96	P6230130	\$186.02		
440 XCR	1992	P6230130	\$186.02	P1332135-067	\$244.95
440 XCR	1991	P6230130	\$186.02		
440 XCF	1997	P6230130	\$186.02	P22001118	\$189.95
440 Supersport	1996	P6230130	\$186.02	P1332146-067	\$139.95
440 Supersport	1994-95	P6230130	\$186.02		

Note: All Axle Assemblies with pressed on clutch-side bearings. Come with the bearing and bearing-holder already installed on shaft.

Diamond Drive, Drive Sprockets

DIAMOND DRIVE, DRIVE SPROCKETS™ are manufactured to OEM quality and durability standards. Made from high quality UHMW by Soucy Plastiques Inc. Molded in 9 and 10 tooth (2.52" pitch) and 8-tooth anti-ratchet (3" pitch) to offer flexibility in track options and tuning requirements. Manufactured to fit the larger diameter track shaft. **WARNING:** It is the responsibility of the purchaser to check for tunnel clearance before changing sprocket size. Each sprocket has a different diameter and may affect track to tunnel clearance.



Description	Part #	Price (B)
8 Tooth (3" pitch)	SW- 50032	\$72.74

SPEEDWERX
STRAIGHT-UP USA HORSEPOWER

Light Weight Track-shaft

Black Diamond's LWT™ light weight track-shaft reduces 2 pounds of rotating mass on the M7. The LWT™ utilizes a PATENT PENDING slip washer with a shorter, higher grade bolt to replace the heavier, lower grade OEM bolt. The LWT™ is machined with an interior collar that the slip washer is pressed against and produces a stronger and lighter connection to the output shaft of the Diamond Drive™.

Description	Part #	Price (B)
All M-Series '05-'06	SW-50040	\$145.55
M-Series with 8 Tooth Driver Installed	SW-50047	\$275.24
Crossfire with 10 Tooth drivers Installed	SW-50043	\$218.37
ZR '04-'06	SW-50042	\$145.55



SPEEDWERX
STRAIGHT-UP USA HORSEPOWER

HPCO Lube Kit

Black Diamond's HPCO LUBE KIT™ is a complete service kit for the DIAMOND DRIVE™. The HPCO LUBE KIT™ uses superior synthetics that exceed OEM specifications to improve lubrication and reduce wear in demanding high performance applications. The HPCO LUBE KIT™ is a complete convenient change kit, that comes with the exact amount of High Performance Case Oil, the correct gasket material, and the drain plug o-ring. The HPCO LUBE KIT™ is engineered for the recommended annual fluid change or gear change to provide maximum performance and durability in all applications.



Description	Part #	Price (E)
HPCO Lube Kit	SW-50024	\$25.19

Diamond Drive Gears \$321.46 (B)

Improve performance by fine tuning the Diamond Drive with a choice of 17 different gear ratios. Ranging from high 1.62 to low 2.76. High quality gears manufactured to exact OEM specification. Cut from billet material and heat treated for strength and durability. Manufactured in the USA.

Input/ Transfer Gears	Effective Ratio	Part #
68/52	1.62	SW-66852*
67/53	1.67	SW-66753*
66/54	1.73	SW-66654
65/55	1.79	SW-66555
64/56	1.85	SW-66456
63/57	1.91	SW-66357
62/58	1.98	SW-66258
61/59	2.04	SW-66159
60/60	2.11	SW-66060
59/61	2.18	SW-65961
58/62	2.26	SW-65862
57/63	2.33	SW-65763
56/64	2.41	SW-65664
55/65	2.50	SW-65565
54/66	2.58	SW-65466**
53/67	2.67	SW-65367**
52/68	2.76	SW-65268**

* = High speed gears, case modification may be necessary.

** = Snocross and Mountain Applications.

SPEEDWERX
STRAIGHT-UP USA HORSEPOWER

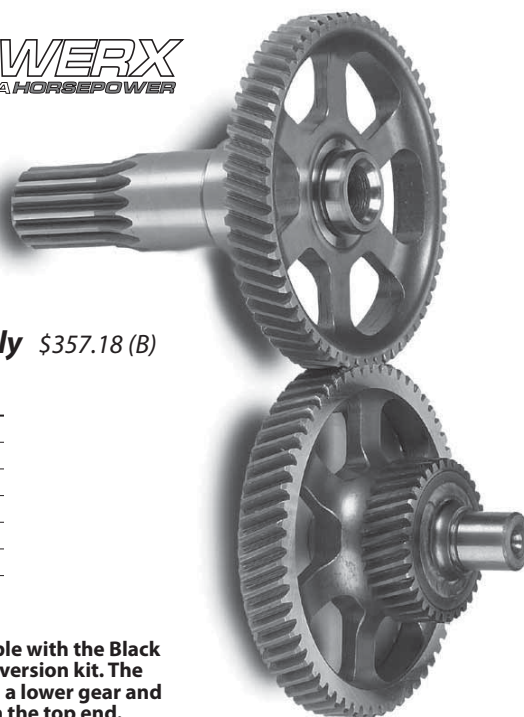
**New! 2007 Reverse Models Only \$357.18 (B)**

Input/ Transfer Gears	Effective Ratio	Part #
68/52	1.62	SW-66852-R
59/61	2.18	SW-65961-R
55/65	2.50	SW-65565-R
54/66	2.58	SW-65466-R
53/67	2.67	SW-65367-R
52/68	2.76	SW-65268-R

NOTE: Lower ratios are available with the Black Diamond 10.4" Clutch Conversion kit. The 10.4" conversion kit starts in a lower gear and reduces belt slippage on the top end.

**Seal Kit**

Black Diamond introduces the DIAMOND DRIVE SEAL KIT™ to protect your DIAMOND DRIVE™ and keep it performing like new. Seal maintenance helps keep the vital lubricating fluids in and damaging moisture out. Black Diamond provides OEM seals that are of an automotive quality for maximum performance. Black Diamond makes it easier to maintain the Diamond Drive with the correct and complete Input and Drive Line seals and oil plug O-ring.

Description	Part #	Price (E)
For '04 Models	SW-50025	\$16.76
For '05 Models	SW-50026	\$16.76
For '06 Models	SW-50041	\$16.76
For '07 Models	SW-50048	\$16.76

**Bearing Kits**

Black Diamond introduces the DIAMOND DRIVE BEARING KIT™ to help maintain peak performance of your Diamond Drive. The DIAMOND DRIVE BEARING KIT™ contains all the OEM bearings needed for a complete Diamond Drive case rebuild. For maximum performance Black Diamond recommends an annual preseason inspection. Preventative maintenance with DIAMOND DRIVE ACCESSORIES™ provide you with the correct and complete OEM parts needed to protect your investment and maximize you snowmobiling experience.

Description	Part #	Price (E)
Bearing Kit™ All Models	SW-50027	\$101.86

OEM Cross Reference Chart

OEM #	Part #	Type	Length	Width
Arctic Cat				
0107-102	017-92-11	Silent	92	11
0107-215	017-68-11	Silent	68	11
0107-216	017-70-11	Silent	70	11
0107-322	017-64-11	Silent	64	11
0107-358	017-66-11	Silent	66	11
0107-372	017-72-11	Silent	72	11
0107-431	017-84-11	Silent	84	11
0107-484	017-88-11	Silent	88	11
0116-049	003-125-4	35-2	90	Double
0602-449	017-70-13	Silent	70	13
0602-450	017-72-13	Silent	72	13

Ski-Doo				
412.1010.00	003-119-6	315-2	90	Double
412.1021.00	003-121-5	3/8"	90	Triple
412.1024.00	003-121-4	3/8"	82	Triple
412.1026.00	003-119-2	315-2	84	Double
412.1028.00	003-119-5	315-2	89	Double
412.1029.00	003-121-7	3/8"	94	Triple
412.1032.00	003-121-3	3/8"	68	Triple
412.1041.00	003-119-4	315-2	88	Double
412.1043.00	003-121-1	3/8"	64	Triple
412.1046.00	003-119-3	315-2	86	Double
412.1047.00	003-121-2	3/8"	66	Triple
412.1048.00	003-118-4	428	62	Single
412.1049.00	017-92-11	Silent	92	11
412.1052.00	003-121-6	3/8"	92	Triple
412.1055.00	017-72-11	Silent	72	11
412.1063.00	003-118-4	428	62	Single
412.1067.00	017-72-15	Silent	72	15

OEM #	Part #	Type	Length	Width
412.1058.00	017-74-11	Silent	74	11
412.1069.00	017-74-13	Silent	74	13
412.1059.00	017-70-11	Silent	70	11
412.1060.00	017-68-11	Silent	68	11
412.1064.00	017-96-11	Silent	96	11
412.1066.00	017-98-11	Silent	98	11
417.1112.00	003-121-5	3/8"	90	Triple
420.4990.46	003-121-9	3/8"	186	Triple
420.4990.47	003-121-8	3/8"	188	Triple
420.4990.80	003-121-6	3/8"	92	Triple
420.4990.86	003-121-5	3/8"	90	Triple
420.4990-88	003-121-7	3/8"	94	Triple

Polaris				
220199	017-88-11	Silent	88	11
3224005	003-125-4	35-2	90	Double
3224023	017-64-11	Silent	64	11
3224052	017-64-13	Silent	64	13
3224057	017-64-15	Silent	64	15
3224024	017-66-11	Silent	66	11
3224051	017-66-13	Silent	66	13
3224058	017-66-15	Silent	66	15
3224025	017-68-11	Silent	68	11
3224061	017-68-13	Silent	68	13
3224068	017-68-15	Silent	68	15
3224031	017-88-11	Silent	88	11

Yamaha				
94860-01064	017-64-11	Silent	64	11
94860-01066	017-66-11	Silent	66	11
94860-01068	017-68-11	Silent	68	11
94860-01070	017-70-11	Silent	70	11

Formula to Calculate MPH

$RPM / GR \times SC / 12 \times 60 / 5280 = MPH$ @ 1:1 clutch ratio

GR = gear ratio (divide top sprocket into bottom sprocket)

SC = sprocket circumference

Formula to Calculate Chain

$(CD \times 2) / .375 + (TS + BS) / 2 = Pitch$

CD = center distance (drive shaft to jackshaft)

TS = top sprocket

BS = bottom sprocket

Round number up to even number for proper pitch

7T-2.52" Pitch = 17.64 SC

8T-2.52" Pitch = 20.16 SC

9T-2.52" Pitch (standard OEM size) = 22.68 SC

10T-2.52" Pitch = 25.2 SC

7T Convolute - 3.29" Pitch = 23.03 SC

Round number up to even number for proper pitch

Gear & Chain Information *for Arctic Cat Applications*

Model	Year	Chain		Bottom		Model	Year	Chain		Bottom	
		Pitch	Top Gear	Top Gear	Gear			Pitch	Top Gear	Top Gear	Gear
Bearcat 340	1995-1997	72P / 13W	18T / 13W	44T / 13W		Sabercat 700	2004-2005	72P / 13W	24T / 13W	39T / 13W	
Cougar/Cougar Mtn. Cat	1990	68P / 11W	20T / 11W	35T / 11W		Sabercat 600	2004-2005	72P / 13W	23T / 13W	40T / 13W	
Cougar/Cougar 2-up	1991-1992	72P / 11W	23T / 11W	40T / 11W		Sabercat 500	2004-2006	70P / 13W	20T / 13W	39T / 13W	
Cougar/Cougar Mtn. Cat	1993-1996	70P / 11W	20T / 11W	39T / 11W		Thundercat	1993-2001	72P / 13W	24T / 13W	39T / 13W	
Cougar/Cougar Mtn. Cat	1997-1998	70P / 13W	20T / 13W	39T / 13W		Thundercat Mountain Cat	1996-1997	72P / 13W	23T / 13W	40T / 13W	
Crossfire 600 / 700	2006	N/A	60T	60T		Thundercat Mountain Cat	1999-2000	70P / 13W	20T / 13W	39T / 13W	
El Tigre EXT/Mountain Cat	1990	68P / 11W	20T / 11W	35T / 11W		Wildcat/Wildcat Mtn. Cat	1990	72P / 11W	24T / 11W	39T / 11W	
El Tigre EXT/Mountain Cat	1991	72P / 11W	23T / 11W	40T / 11W		Wildcat 700/Wildcat 700	1991	72P / 11W	24T / 11W	39T / 11W	
El Tigre EXT Special	1990-1991	70P / 11W	20T / 11W	39T / 11W		Mountain Cat					
EXT/EXT Special/EXT M/C	1992	70P / 11W	20T / 11W	39T / 11W		Wildcat 700	1992	72P / 13W	23T / 13W	40T / 13W	
EXT 550	1993	70P / 11W	20T / 11W	39T / 11W		Wildcat 700 Mountain Cat	1992	72P / 13W	24T / 13W	39T / 13W	
EXT 580/EXT 580 Mtn. Cat	1993-1998	70P / 13W	20T / 13W	39T / 13W		Wildcat 700/Wildcat 700	1993-1996	72P / 13W	23T / 13W	40T / 13W	
EXT 600	1997-1998	72P / 13W	23T / 13W	40T / 13W		Mountain Cat					
Firecat 500	2003	70P / 13W	19T / 13W	40T / 13W		Z 370	1999-2004	72P / 11W	18T / 11W	44T / 11W	
Firecat 500	2004	74P / 13W	23T / 13W	44T / 13W		Z 400	1995	70P / 13W	20T / 13W	39T / 13W	
Firecat 500	2005-2006	N/A	57T	63T		Z 440	1996-2001	70P / 13W	20T / 13W	39T / 13W	
Firecat 600	2004	72P / 13W	23T / 13W	40T / 13W		Z 440	2002	70P / 11W	20T / 11W	39T / 11W	
Firecat 600	2005-2006	N/A	62T	58T		Z 440 S/P	1999	70P / 15W	20T / 15W	39T / 13W	
Firecat 700	2003	72P / 13W	22T / 13W	41T / 13W		Z 440 S/P	2000-2002	70P / 15W	20T / 15W	39T / 13W	
Firecat 700	2004	72P / 13W	24T / 13W	39T / 13W		Z 440 S/P	2003	70P / 15W	19T / 15W	40T / 13W	
Firecat 700	2005	N/A	65T	55T		Z 570	2002-2006	70P / 13W	20T / 13W	39T / 13W	
Firecat 700	2006	N/A	60T	60T		ZL 440	1997-2000	70P / 13W	20T / 13W	39T / 13W	
Jag/Jag Deluxe/Jag M/Cat	1990-1997	70P / 11W	20T / 11W	39T / 11W		ZL 500	1999-2002	70P / 13W	20T / 13W	39T / 13W	
Jag 340 / Jag 340 Deluxe	1998-1999	72P / 11W	18T / 11W	44T / 11W		ZL 550	2001-2003	70P / 13W	20T / 13W	39T / 13W	
Jag 440	1999	70P / 11W	20T / 11W	39T / 11W		ZL 600	1999-2000	70P / 13W	20T / 13W	39T / 13W	
Jag 440 Deluxe	2000	70P / 11W	18T / 11W	39T / 11W		ZL 600	2001-2003	72P / 13W	22T / 13W	41T / 13W	
King Cat 900	2005-2006	72P / 3/4W	19T / 3/4W	43T / 3/4W		ZL 700	2000	72P / 13W	23T / 13W	40T / 13W	
M-Series 500 / 600 / 700	2005-2006	N/A	57T	63T		ZR 400	1995	70P / 13W	20T / 13W	39T / 13W	
Mountain Cat 1000	2001-2002	70P / 13W	20T / 13W	39T / 13W		ZR 440	1993-1997	70P / 13W	20T / 13W	39T / 13W	
Mountain Cat 500 EFI	2001-2002	70P / 13W	19T / 13W	40T / 13W		ZR 440	1998	70P / 13W	19T / 13W	40T / 13W	
Mountain Cat 570	2002	70P / 13W	19T / 13W	39T / 13W		ZR 440 S/P	1998	70P / 13W	20T / 13W	39T / 13W	
Mountain Cat 570	2003-2004	72P / 13W	18T / 13W	44T / 13W		ZR 440 S/P	1999	70P / 15W	20T / 15W	39T / 13W	
Mountain Cat 600 EFI	2001-2002	70P / 13W	19T / 13W	40T / 13W		ZR 440 S/P	2000-2001	70P / 15W	19T / 15W	40T / 13W	
Mountain Cat 600	2003-2004	72P / 13W	18T / 13W	44T / 13W		ZR 500	1998-2002	70P / 13W	20T / 13W	39T / 13W	
Mountain Cat 800	2001-2002	70P / 13W	20T / 13W	39T / 13W		ZR 600	1998-2002	70P / 13W	20T / 13W	39T / 13W	
Mountain Cat 800	2003-2004	72P / 13W	19T / 13W	43T / 13W		ZR 580	1993-1997	70P / 13W	20T / 13W	39T / 13W	
Mountain Cat 900 1M	2003-2004	72P / 15W	43T / 13W	19T / 15W		ZR 700	1994-1995	72P / 13W	23T / 13W	40T / 13W	
Panther/Panther Mtn. Cat	1990-1996	70P / 11W	20T / 11W	39T / 11W		ZR 700	1999	72P / 13W	24T / 13W	40T / 13W	
Panther 340	1998-2000	72P / 11W	18T / 11W	44T / 11W		ZR 700	2000	72P / 13W	23T / 13W	40T / 13W	
Panther 370	2001	72P / 13W	18T / 13W	44T / 13W		ZR 800	2001-2003	72P / 13W	24T / 13W	39T / 13W	
Panther 440	2001-2002	70P / 13W	20T / 13W	39T / 13W		ZR 900	2003	74P / 15W	26T / 15W	41T / 13W	
Powder Extreme	1997	72P / 13W	23T / 13W	40T / 13W		ZR 900	2005-2006	N/A	66T	54T	
Powder Extreme	1998	70P / 13W	20T / 13W	39T / 13W		ZRT 600	1995-2002	72P / 13W	23T / 13W	40T / 13W	
Powder Special	1997&2000	70P / 13W	20T / 13W	39T / 13W		ZRT 800	1995-2001	72P / 13W	24T / 13W	39T / 13W	
Powder Special	1998-1999	70P / 13W	19T / 13W	40T / 13W		4-Stroke Trail	-----	72P / 13W	18T / 13W	44T / 13W	
Powder Spec. 500-600 EFI	2000	70P / 13W	19T / 13W	40T / 13W		440 S/P	2004	72P / 15W	19T / 15W	43T / 15W	
Powder Special 600 CARB	2000	70P / 13W	18T / 13W	40T / 13W		440 S/P	2006	74P / 3/4W	20T / 3/4W	46T / 3/4W	
Powder Special 700	2000	70P / 13W	19T / 13W	40T / 13W							
Prowler/Prowler Mtn. Cat	1991-1994	70P / 11W	20T / 11W	39T / 11W							
Puma/Puma 2-up/Dlx.	1994-1997	70P / 11W	18T / 11W	40T / 11W							

Gear & Chain Information *for Polaris Applications*

Model	Year	Top	Bottom	Pitch	Width	Type
120 XCR	2000	--	42	--	----	#40
120 XC SP	2003	--	42	--	----	#40
120 ProX	2004-06	10	42	--	----	#40
340 Classic	2003	16	41	72	3/4"	HYVO
340 Classic	2004-06	16	41	72	3/4"	HYVO
340 Deluxe	1999-2002	17	41	66	3/4"	HYVO
340 Touring	2000, 02-04	17	41	66	3/4"	HYVO
340 Touring	2005-06	17	41	74	3/4"	HYVO
400	1985-90	19	35	64	11	Silent
400 SKS	1988	18	35	64	11	Silent
440	1992, 94-97	21	39	66	11	Silent
440	1998	22	41	68	3/4"	HYVO
440	1993	21	39	64	11	Silent
440 IQ	2005	19	45	76	7/8"	
440 ProX	2002	20	42	74	3/4"	HYVO
440 ProX	2003	19	43	74	3/4"	HYVO
440 ProX Fan	2002-03	21	41	74	3/4"	HYVO
440 ProXR	2004	19	43	74	3/4"	HYVO
440 SKS	1993-95	20	39	66	11	Silent
440 XC	1991	21	39	66	11	Silent
440 XC	1997	21	39	66	13	Silent
440 XC SP	1999	21	41	70	3/4"	HYVO
440 XCR	1992, 1996	21	39	66	11	Silent
440 XCR	1993, 1995	21	39	66	13	Silent
440 XCR	1997	22	41	70	15	Silent
440 XCR	1998	21	39	68	3/4"	HYVO
440 XCR SP	1996	21	39	66	11	Silent
500	1989-90	19	35	64	11	Silent
500	1991, 95-96	21	39	66	11	Silent
500	1997	21	39	66	13	Silent
500	1998	22	41	68	3/4"	HYVO
500 Classic	1992	20	29	66	11	Silent
500 Classic	1993	21	39	64	11	Silent
500 Classic	1994-95	21	39	66	11	Silent
500 Classic	1996-97	21	39	66	13	Silent
500 Classic	1998	22	41	68	3/4"	HYVO
500 Classic	1999	22	41	70	3/4"	HYVO
500 Classic	2000	21	39	66	3/4"	HYVO
500 Classic	2001	21	39	66	3/4"	HYVO
500 Classic	2002, 05-06	21	40	74	3/4"	HYVO
500 Classic	2003	19	39	72	3/4"	HYVO
500 Classic	2004	18	40	74	3/4"	HYVO
500 Classic Tour.	1994	20	39	66	11	Silent
500 Classic Tour.	1996	20	39	66	11	Silent
500 Classic Tour.	1997	19	39	66	13	Silent
500 Classic Tour.	1998, 02-03	19	40	66	3/4"	HYVO
500 Edge	2003-04	21	40	74	3/4"	HYVO
500 EFI	1993	21	39	64	11	Silent
500 EFI	1994-95	21	39	66	11	Silent
500 EFI	1996-97	21	39	66	13	Silent
500 EFI RMK	1996	18	39	66	11	Silent
500 EFI SKS	1993-96	20	39	66	11	Silent
500 EFI SKS PT	1995	20	39	66	11	Silent
500 INDY	1999	22	41	70	3/4"	HYVO
500 INDY	2000	21	39	66	3/4"	HYVO
500 INDY	01-02, 05-06	21	40	74	3/4"	HYVO
500 RMK	1996	18	39	66	11	Silent
500 RMK	1997	19	49	66	13	Silent
500 RMK	1998	17	41	66	13	Silent
500 RMK	1999	17	41	66	3/4"	HYVO
500 RMK	2000-01	18	41	68	3/4"	HYVO
500 RMK (136)	2002	18	41	68	3/4"	HYVO
500 SKS	1989-90	18	35	64	11	Silent
500 SKS	1991, 1996	20	39	66	11	Silent
500 SKS	1992	21	39	66	11	Silent
500 SKS	1997	20	39	66	13	Silent
500 SP	1992	21	39	66	11	Silent
500 XC	1999-2000	22	41	70	3/4"	HYVO
500 XC	2001	22	40	72	3/4"	HYVO
500 XC	2002-03	22	40	74	3/4"	HYVO
500 XC SP	1999	22	41	70	3/4"	HYVO

Model	Year	Top	Bottom	Pitch	Width	Type
500 XC SP	2001-06	22	40	74	3/4"	HYVO
500 XCSP (M-10)	2002-05	22	40	74	3/4"	HYVO
550 Classic	2002, 04-06	19	39	72	3/4"	HYVO
550 ProX Fan	2004	21	41	74	3/4"	HYVO
600	1985	19	35	64	11	Silent
600	1986-87	21	35	64	11	Silent
600 Classic	2001	22	40	74	3/4"	HYVO
600 Classic	2002	23	39	74	3/4"	HYVO
600 Classic	2003-06	23	39	74	3/4"	HYVO
600 Classic Tour.	2001	19	40	68	3/4"	HYVO
600 Classic Tour.	2002	18	40	68	3/4"	HYVO
600 Classic Tour.	2003	20	40	66	3/4"	HYVO
600 HO Fusion	2006	23	39	76	3/4"	HYVO
600 HO RMK (144)	2006	20	41	76	3/4"	HYVO
600 HO Switchback	2006	22	39	76	3/4"	HYVO
600 ProX	2002	24	41	76	3/4"	HYVO
600 ProX	2003-04	23	39	74	3/4"	HYVO
600 ProX-2	2004	23	39	74	3/4"	HYVO
600 Switchback	2004-05	22	40	74	3/4"	HYVO
600 RMK	1998-99	19	40	66	3/4"	HYVO
600 RMK	2001	19	49	68	3/4"	HYVO
600 RMK (136)	2002	19	39	72	3/4"	HYVO
600 RMK (144)	2003, 05-06	19	39	72	3/4"	HYVO
600 RMK	2004	19	39	72	3/4"	HYVO
600 Touring	2005-06	21	41	74	3/4"	HYVO
600 XC	1997	21	39	66	13	Silent
600 XC	1998-99	22	40	70	3/4"	HYVO
600 XC Deluxe	2000	22	41	70	3/4"	HYVO
600 XC SP	1999	22	40	70	3/4"	HYVO
600 XC SP	2000-05	23	39	74	3/4"	HYVO
600 XC SP (M-10)	2002-05	23	39	74	3/4"	HYVO
600 XCR	1994-96	21	39	66	11	Silent
600 XCR	1997	21	35	64	13	Silent
600 XCR	1998	23	40	68	3/4"	HYVO
600 XCR SP	1996	21	35	64	13	Silent
650	88-89, 1991	21	35	64	11	Silent
650	1990	19	35	64	11	Silent
650	1992	21	39	66	11	Silent
650 SKS	1989, 1991	19	35	64	11	Silent
650 SKS	1990	18	35	64	11	Silent
700 Classic	2001	23	40	70	3/4"	HYVO
700 Classic	2002	23	39	74	3/4"	HYVO
700 Classic	2002	25	41	76	3/4"	HYVO
700 Classic	2003-04	25	40	76	3/4"	HYVO
700 Classic Tour.	2003	22	40	74	3/4"	HYVO
700 HO Fusion	2006	26	40	78	3/4"	HYVO
700 ProX	2003-04	25	41	76	3/4"	HYVO
700 ProX-2	2004	25	41	76	3/4"	HYVO
700 RMK	1997	20	39	66	13	Silent
700 RMK	1998-99	21	41	70	3/4"	HYVO
700 RMK	2000	20	39	68	3/4"	HYVO
700 RMK	2004	19	39	72	3/4"	HYVO
700 RMK	2003	23	39	74	3/4"	HYVO
700 RMK (151)	2002	19	39	72	3/4"	HYVO
700 RMK (151)	2003	21	41	74	3/4"	HYVO
700 RMK (144)	2001	19	40	68	3/4"	HYVO
700 RMK (144)	2002, 05-06	19	39	72	3/4"	HYVO
700 RMK (144)	2003	21	41	74	3/4"	HYVO
700 RMK (136)	2001	20	39	68	3/4"	HYVO
700 RMK (136)	2002	21	41	74	3/4"	HYVO
700 SKS	1997	20	35	66	13	Silent
700 SKS	2000-02	23	40	70	3/4"	HYVO
700 SKS	2003	23	39	74	3/4"	HYVO
700 Switchback	2004	23	39	74	3/4"	HYVO
700 XC	1997-98	24	40	70	3/4"	HYVO
700 XC	1999	24	40	68	3/4"	HYVO
700 XC	2001	23	39	74	3/4"	HYVO
700 XC Deluxe	2000	23	40	70	3/4"	HYVO
700 XC Edge	2004	25	41	76	3/4"	HYVO
700 XC SP	1999	24	40	68	3/4"	HYVO
700 XC SP	2000	24	40	70	3/4"	HYVO

Model	Year	Top	Bottom	Pitch	Width	Type	Model	Year	Top	Bottom	Pitch	Width	Type
700 XC SP	2002-03	25	40	76	3/4"	HYVO	Storm RMK	1997	20	39	64	15	Silent
700 XC SP (M-10)	2002-05	25	40	76	3/4"	HYVO	Storm SE	1997	23	37	66	15	Silent
700 XCR	1998-99	24	40	68	3/4"	HYVO	Supersport	1995-96	17	35	62	11	Silent
750 Storm	1993-94	23	37	66	13	Silent	Supersport	1997	21	39	66	13	Silent
750 Storm SKS	1993	23	37	66	13	Silent	Supersport	1998	22	41	68	3/4"	HYVO
750 Storm SKS	1994	21	37	66	13	Silent	Supersport	1999	19	39	64	3/4"	HYVO
800 Classic	2004	25	40	76	3/4"	HYVO	Supersport	2000-01	19	39	66	3/4"	HYVO
800 Classic Tour.	2003	22	40	74	3/4"	HYVO	Supersport	2002-06	19	39	72	3/4"	HYVO
800 LE Edge	2001	25	41	76	3/4"	HYVO	Supertrack	1989-92	19	39	66	11	Silent
800 ProX	2003-04	25	40	76	3/4"	HYVO	Touring	1993	20	39	66	11	Silent
800 ProX-2	2004	25	40	76	3/4"	HYVO	Trail	1985	19	35	64	11	Silent
800 ProXR	2004	25	40	76	3/4"	HYVO	Trail	1986-91	21	35	64	11	Silent
800 RMK	2000	22	41	70	3/4"	HYVO	Trail	1992, 94-97	21	39	66	11	Silent
800 RMK	2001	20	39	68	3/4"	HYVO	Trail	1993	21	39	64	11	Silent
800 RMK (144)	2002-05	21	41	74	3/4"	HYVO	Trail	1998	22	41	68	3/4"	HYVO
800 RMK (151)	2002-05	21	41	74	3/4"	HYVO	Trail	1999	22	41	70	3/4"	HYVO
800 RMK (156)	2002	19	39	72	3/4"	HYVO	Trail Deluxe	1991-92	21	39	66	11	Silent
800 RMK (159)	2003, 2005	19	39	72	3/4"	HYVO	Trail Deluxe	1994-95	22	41	64	11	Silent
800 SKS	2003	23	39	74	3/4"	HYVO	Trail RMK	1997	19	40	66	11	Silent
800 Storm	1995-96	23	37	66	13	Silent	Trail RMK	1998-99	18	41	66	3/4"	HYVO
800 Storm	1998	25	40	70	3/4"	HYVO	Trail RMK	2000-02	18	41	68	3/4"	HYVO
800 Storm RMK	1996	20	39	66	13	Silent	Trail RMK	2003	18	41	74	3/4"	HYVO
800 Storm SKS	1995	20	35	66	13	Silent	Trail RMK	2004	17	39	72	3/4"	HYVO
800 Storm SKS	1996	29	36	64	13	Silent	Trail RMK (136)	2005-06	19	43	74	3/4"	HYVO
800 Storm SKS PT	1995	20	35	66	13	Silent	Trail SKS	1988	19	35	64	11	Silent
800 Switchback	2004-05	23	39	74	3/4"	HYVO	Trail Touring	1996-97	20	39	66	11	Silent
800 XC	2001	25	41	76	3/4"	HYVO	Trail Touring	1998-99	20	40	66	3/4"	HYVO
800 XC Edge	2004	25	40	76	3/4"	HYVO	Trail Touring	2000, 02-03	19	40	66	3/4"	HYVO
800 XC SP	2002-03	25	40	76	3/4"	HYVO	Trail Touring	2004-06	19	41	74	3/4"	HYVO
800 XCSP (M-10)	2002-05	25	40	76	3/4"	HYVO	Transport	1996-97	15	39	64	11	Silent
800 XCR	1999	24	39	68	3/4"	HYVO	Transport	1998	15	39	64	13	Silent
800 XCR	2000-03	24	39	70	3/4"	HYVO	Transport	1999	16	39	64	3/4"	HYVO
900 Fusion	2005-06	25	37	76	3/4"	HYVO	Ultra	1997	21	35	64	13	Silent
900 RMK	2005	19	39	90	3/4"	HYVO	Triumph	2000	21	39	66	3/4"	HYVO
900 Switchback	2005	24	37	92	3/4"	HYVO	Ultra	1998	23	40	68	3/4"	HYVO
Classic Touring	1999-2000	19	40	66	3/4"	HYVO	Ultra RMK	1996	20	39	66	13	Silent
Frontier	2002	17	40	72	3/4"	HYVO	Ultra SKS	1996	20	35	64	13	Silent
Frontier Classic	2003	18	39	72	3/4"	HYVO	Ultra SE	1997	21	35	64	13	Silent
Frontier Classic	2004	19	39	72	3/4"	HYVO	Ultra SP	1996-97	21	35	64	13	Silent
Frontier Touring	2003	18	41	74	3/4"	HYVO	Ultra SPX	1997	21	35	64	13	Silent
Frontier Touring	2004-05	20	41	74	3/4"	HYVO	Ultra Touring	1997	20	35	64	13	Silent
Lite	1993-97	16	39	64	11	Silent	Ultra Touring	1998	22	40	68	3/4"	HYVO
Lite	1998	16	39	64	13	Silent	Vertical Escape	2003-04	19	39	72	3/4"	HYVO
Lite Deluxe	1993-97	16	39	64	11	Silent	Widetrack	1990-93	19	41	66	11	Silent
Lite Deluxe	1998	16	39	64	13	Silent	Widetrack GT	1994-95	19	41	66	11	Silent
Lite GT	1992-97	16	39	64	11	Silent	Widetrack GT	1996	18	41	66	11	Silent
Lite Touring	1998	16	39	64	13	Silent	Widetrack LX	1994-95	19	41	66	11	Silent
Longtrack	1985	19	35	64	11	Silent	Widetrack LX	1996	18	41	66	11	Silent
Longtrack	1986-89	19	39	66	11	Silent	Widetrack LX	1999	19	41	66	3/4"	HYVO
RXL	1991-92	20	35	64	11	Silent	Widetrack LX	2001	19	41	66	3/4"	HYVO
RXL	93-94, 1996	20	35	64	13	Silent	XCF	1997	20	39	66	11	Silent
RXL	1995	20	35	66	13	Silent	XCF	1998	19	39	66	3/4"	HYVO
RXL	1997	20	35	64	15	Silent	XCF	1999	19	40	66	3/4"	HYVO
RXL SKS	1992	21	39	66	11	Silent	XCF	2000	21	41	74	3/4"	HYVO
RXL SKS	1993-94	21	39	66	13	Silent	XCR	1994	21	39	66	13	Silent
RXL Touring	1995	21	39	66	13	Silent	XCR SP	1994	21	39	66	11	Silent
Sport	87-90, 1997	17	35	62	11	Silent	XLT	1993-97	21	39	66	13	Silent
Sport	1991-96	16	35	62	11	Silent	XLT Classic	1998	22	41	68	3/4"	HYVO
Sport	1998	17	35	62	13	Silent	XLT Classic	1999	22	41	70	3/4"	HYVO
Sport	1999	19	39	66	3/4"	HYVO	XLT EXTRA-12	1994	21	39	66	13	Silent
Sport	2000	19	49	66	3/4"	HYVO	XLT LTD. SP	1997	21	39	66	15	Silent
Sport Touring	1995-97	16	39	64	11	Silent	XLT LTD.	1998	22	41	68	3/4"	HYVO
Sport Touring	1998	17	41	66	13	Silent	XLT RMK	1996	18	39	66	13	Silent
Sport Touring	1999	17	41	66	3/4"	HYVO	XLT RMK	1997	18	40	66	13	Silent
Sport Touring	2000, 02-03	18	40	68	3/4"	HYVO	XLT SKS	1993-97	20	39	66	13	Silent
Sport Touring	2001	18	40	68	3/4"	HYVO	XLT SKS PT	1995	20	39	66	13	Silent
Sport Touring	2004	21	41	74	3/4"	HYVO	XLT SP	1993-97	21	39	66	13	Silent
Sport GT	1989-90	17	35	62	11	Silent	XLT SP	1998	22	41	68	3/4"	HYVO
Sport GT	1991-92	16	39	64	11	Silent	XLT SP	1999	22	41	70	3/4"	HYVO
Sport SKS(rental)	1994	16	39	62	11	Silent	XLT Touring	1995-96	20	39	66	13	Silent
Starlite	1993-95	15	41	66	11	Silent	XLT Touring	1997	20	40	66	13	Silent
Starlite GT	1993-94	15	41	66	11	Silent	XLT Touring	1998-99	20	40	66	3/4"	HYVO
Startrack	1987-90	15	39	64	11	Silent							

Silent Chain by "Link Belt"

All Chains are american made by Link Belt Inc. They fit Arctic Cat, John Deere, Polaris, Skidoo, Yamaha

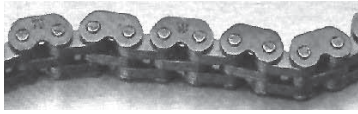

Length	Style	Part #	Price
64 links	11	017-64-11	\$67.95
66 links	11	017-66-11	\$71.95
68 links	11	017-68-11	\$72.37
70 links	11	017-70-11	\$74.95
72 links	11	017-72-11	\$79.95
74 links	11	017-74-11	\$79.95
84 links	11	017-84-11	\$59.95
90 links	11	017-90-11	\$59.95

64 links	13	017-64-13	\$79.95
66 links	13	017-66-13	\$81.95
68 links	13	017-68-13	\$83.95
70 links	13	017-70-13	\$89.95
72 links	13	017-72-13	\$91.95
74 links	13	017-74-13	\$104.95
76 links	13	017-76-13	\$129.78
78 links	13	017-78-13	\$99.95
80 links	13	017-80-13	\$99.95
82 links	13	017-82-13	\$99.95
84 links	13	017-84-13	\$99.95
86 links	13	017-86-13	\$99.95
88 links	13	017-88-13	\$99.95
96 links	13	017-96-13	\$99.95
98 links	13	017-98-13	\$99.95

64 links	15	017-64-15	\$110.62
66 links	15	017-66-15	\$111.94
68 links	15	017-68-15	\$116.16
70 links	15	017-70-15	\$119.95
72 links	15	017-72-15	\$122.85
74 links	15	017-74-15	\$122.65
76 links	15	017-76-15	\$128.77

Part#	Price	Description
003-118-4	\$16.95	#428H-Single 62 Links - 1/2" Pitch
003-125-4	\$29.99	35-2 Double, 90 Links
003-119-2	\$21.95	#315-2-Double 84 Links - 3/8" Pitch
003-119-3	\$24.95	#315-2-Double 86 Links - 3/8" Pitch
003-119-4	\$27.99	#315-2 - Double 88 Links - 3/8" Pitch
003-119-5	\$24.95	#315-2 89 Links - 3/8" Pitch
003-119-6	\$25.95	#315-2 90 Link - 3/8" Pitch
003-121-1	\$37.95	3/8" Pitch, Triple, 64 Links
003-121-2	\$42.95	3/8" Pitch, Triple, 66 Links
003-121-3	\$42.99	3/8" Pitch, Triple, 68 Links
003-121-4	\$46.95	3/8" Pitch, Triple, 82 Links
003-121-5	\$46.99	3/8" Pitch, Triple, 90 Links
003-121-6	\$47.99	3/8" Pitch, Triple, 92 Links
003-121-7	\$49.99	3/8" Pitch, Triple, 94 Links
003-121-8	\$115.95	3/8" Pitch, Triple, 188 Link
003-121-9	\$99.95	3/8" Pitch, Triple, 186 Link
003-122	\$99.95	1/2" Pitch, Triple, 78 Link
003-125-4	\$29.99	35-2, Double, 90 Link

Application Guide

Model	Year	Part #
Arctic Cat		
Bearcat 340	1995-99	017-72-13
Bearcat 440,550	1995-99	017-70-13
Chhetah 340	1972	003-125-4
Cheetah	1973-75	017-92-11
Cheetah f/c	1986-87	017-68-11
Cheetah 295	1975	017-92-11
Cheetah 340	1972	003-125-4
Cheetah 340,440	1973-77	017-90-11
Cheetah 500	1976	017-88-11
Cheetah 5000	1978	017-90-11
Cheetah l/c	1986-87	017-72-11
Cheetah l/c	1988	017-68-11
Touring	1988-94	017-70-11
Cougar	1968	003-125-4
Cougar SE	1985	017-72-11
Cougar SE	1986-90	017-68-11
Cougar H.A.	1991	017-72-11
Cougar M.C.	1990	017-68-11
Cougar M.C.	1988-98	017-70-13
Cougar, 2 up	1991	017-72-11
Cougar, 2 up	1992-95	017-70-11
Cross Country	1976-77	017-68-11
El-Tigre 295, 340	1974-75	017-70-11
El-Tigre 340,400,440	1973	017-70-11
El-Tigre 400,440	1974-76	017-72-11
El-Tigre 4000,5000	1977-81	017-72-11
El-Tigre 440	1975-76	017-68-11
El-Tigre 500	1976	017-68-11
El-Tigre 5000	1988	017-70-11
El-Tigre 6000	1988-89	017-68-11
El-Tigre 6000	1978-87	017-72-11
El-Tigre M.C.	1990	017-68-11
El-Tigre XC	1979	017-66-11
El-Tigre Z 250	1973-77	017-68-11
El-Tigre Z 340	1975	017-70-11
EXT	1989-90	017-68-11
EXT 340	1973	017-68-11
EXT 340	1970-71	003-125-4
EXT 440,650	1973	017-70-11
EXT 580,EFI,MC	1993-98	017-70-13
EXT 600	1997-99	017-72-13
EXT SP, EFI	1990-92	017-70-11
EXT M.C.	1991	017-72-11
Jag AFS,Dlx	75-80	017-70-11
	88-97	
Jag 275,340,3000	1976-80	017-70-11
Jag 340	1975	017-70-11
Jag 340,Dlx.	1988-97	017-70-11
Jag 2000F/A	1978-80	017-70-11
Jag 4000	1981	017-68-11
Jag L/T	1981	017-72-11
Lynx 250	1975	017-84-11
Lynx 2000T	1978	017-90-11
Lynx Dlx	1991-93	017-70-11
Pantera 340	1975	017-92-11
Pantera 436,440	1988-92	017-68-11
Pantera 440	1975	017-90-11
Pantera 550,580	1993-98	017-70-13
Pantera 800	1998-99	017-72-13
Pantera 5000	1976	017-70-11
Pantera f/a	77-80/88	017-68-11
Pantera f/c	1977-80	017-66-11
Pantera	1980-88	017-68-11
Pantera L/C	1985-87	017-72-11
Panther	1984-88	017-68-11
Panther	1968-70	003-125-4

Model	Year	Part #
Panther	1971	003-125-4
Panther 295,340	1973	017-90-11
Panther 295	1974	017-90-11
Panther 340	1974	017-92-11
Panther 400,440	1973	017-92-11
Panther 440	1974-76	017-90-11
Panther 440,550	1996-99	017-70-13
Panther 500	1976	017-88-11
Panther 4000,5000	1977-79	017-90-11
Panther Dlx.	1989-96	017-70-13
Powder Extreme 600	1997-98	017-70-13
Powder Special	1995-99	017-70-13
580,600		
Prowler	1990-95	017-70-11
Puma	1970-72	003-125-4
Puma 440	1973	017-92-11
Puma	1994-97	017-70-11
Super Jag	1988-92	017-70-11
Super Jag	1987	017-68-11
Thundercat	1993-99	017-72-13
Hi Altitude	1993-99	017-70-13
Trail Cat 4000	1980-81	017-72-11
Trail Cat F/C	1979-80	017-70-11
Wildcat 650,700MC	1988-95	017-72-13
Wildcat 700 HA	1996	017-70-11
Wildcat MC, EFI	1992-93	017-70-11
Z 340	1977	017-66-11
Z 440	1976-77	017-70-11
Z,ZL 440,500,600	1994-99	017-70-13
ZR 440, 500, 580,	1993-99	017-70-11
600, EFI		
ZR 700	1994-95	017-72-11
ZRT 600,800	1995-99	017-72-13
ZRT 600,800(H.A.)	1995-99	017-70-13

John Deere		
300	1974	003-125-4
400	1975-77	003-125-4
400,500	1972-74	003-125-4
600, JDX 4	1973-75	003-125-4
Cyclone 340	1976-78	017-66-11
Cyclone 440	1976-78	017-68-11
Liquidator	1976	017-66-11
Liquifire 340	1976-78	017-66-11
Liquifire 440	1980-83	017-66-11
Liquifire 440	1976-78	017-68-11
Sportfire 440	1980-83	017-66-11
Trailfire 340	1979	017-66-11
Trailfire 440	1980-83	017-66-11
Trailfire 440	1979	017-68-11

Kawasaki		
Drifter 340	1979-81	017-90-11
Drifter 440	1979-81	017-92-11
Interceptor	1981-82	017-66-11
Intriguer 440	1978	017-92-11
Intruder 440	1978-82	017-66-11
Invader 340	1978-80	017-64-11
Invader 440	1978-81	017-66-11
Inviter 340	1978	017-90-11
Limited 440	1980-81	017-66-11

Moto-Ski		
Futura 400	1977-79	003-119-6
Futura 440	1976-79	003-121-7
Futura 444	1980-82	003-121-1
Futura 444	1978-79	003-121-5
Futura 500	1980-82	003-121-3
Grand Prix SP	1979-81	003-121-3

Model	Year	Part #
Mirage 300	1979	003-119-4
Mirage I, II	1980-83	003-119-3
Mirage III	1985	003-119-4
Mirage SP	1985	003-119-4
Nuvik 300, 340	1975-79	003-119-4
Nuvik 300,340 (twin)	1975-76	003-119-5
Nuvik 440 (twin)	1977	003-121-5
Sonic 250	1976	003-119-6
Sonic 340TS	1975-78	003-121-6
Sonic L/C	1984	003-121-6
Spirit 250	1976-83	003-118-4
Super Sonic	1981-82	003-121-2
Super Sonic	1979	003-121-6
Super Sonic XC	1979	003-121-7
Ultra Sonic	1980-82	003-121-3
Polaris		
Apollo 340,440	1979-80	017-88-11
Cent. 500 STD	1979-82	017-64-11
Charger	1969-73	003-125-4
Cobra 240, 440	1978-79	017-88-11
Custom 400	1973-74	003-125-4
Electra 250,340	1974-77	003-125-4
Galaxy340,440	1980-81	017-88-11
Grizzly	1982-85	003-122
Indy 400	1984-90	017-64-11
Indy 400 XC	1991	017-66-11
440,XCR, SKS	1992-97	017-66-11
Indy 500, Classic, SKS	1989-90	017-64-11
Indy 500, Classic, SKS	1991-97	017-66-11
Indy 500 SP, EFI	1992-97	017-66-11
Indy 600	1983-87	017-64-11
Indy 650 SKS	1988-90	017-64-11
Indy 650 RXL	1990-92	017-64-11
Indy 650,SKS,EFI	1992	017-66-11
Indy 700, SKS	1997	017-66-13
Indy Lite, DLX GT	1991-97	017-64-11
Indy Lite, Dlx.	1993-97	017-64-11
Indy SP	1989-90	017-64-11
Indy SP GT	91-92	017-64-11
	94-97	
Indy Supertrak	1989-92	017-66-11
Indy Starlite	1993-95	017-66-11
Indy Starlite GT	1993-95	017-64-11
Indy Storm, SK	1993-96	017-66-13
Indy Storm, SKS	1997-98	017-66-15
Indy Touring	1994-95	017-66-11
Indy Trail	1983-91	017-64-11
Indy Trail	1992-95	017-66-11
Indy Trail Dlx	1991-93	017-64-11
Indy Trail Dlx	1992	017-66-11
Indy Trail, Tour, RMK	1996-97	017-66-11
Indy X-City	1983	017-66-11
Indy XCR 600	1994-95	017-66-11
Indy Widetrak	1990-95	017-66-11
Longtrak	1983-89	017-66-11
Mustang	1969-73	003-125-4
RXL, SKS	1993-95	017-66-13
Starfire250,340	1976	017-64-11
Startrak	1987-90	017-64-11
Starlite GT	1993	017-64-11
Supersport	1997	017-66-11
Supertrak	1989-92	017-66-11
TC-X 440	1981-82	017-64-11
Transport	1996-97	017-64-11
TX (all)	1972-75	003-125-4
TX 250	1976-79	017-64-11
TX 340,440	1976-80	017-66-11
TX-C 340	1978-82	017-66-11
TX-L 340	1977-82	017-66-11

Model	Year	Part #
TX-L Widetrak	1989-94	017-66-11
TX Charger	1970-72	003-125-4
TX Colt	1970	003-125-4
TX Playmate	1970	003-125-4
TX Racer	1971-72	003-125-4
Voyager	1970-71	003-125-4
Widetrak GT, L	1994-97	017-66-11
XCF	1997	017-66-11
XCR 440	1993-97	017-66-13
XCR 600	1994-97	017-66-13
XLT (all)	1993-97	017-66-13

Ski-Doo

Alpine 440	1973-74	003-121-7
Alpine 503	1983-87	003-121-6
Alpine 640	1973-82	003-121-5
Blizzard	1972	003-121-4
Blizzard	1970-71	003-119-4
246,292,340,436		
Blizzard 5500,9500	1979-82	003-121-3
Blizzard 636, 736	1970	003-119-6
Blizzard 6500 +	1978	003-121-6
Blizzard 7500 +	1980-81	003-121-2
Blizzard7500 +	1979	003-121-6
Blizzard 9700 MX	1983-84	003-121-3
Blizzard XC	1979	003-121-7
Citation 300, SS	1978-83	003-119-4
Citation 3500,4500	1980-84	003-119-3
Elan 250	1973-96	003-118-4
Elan 250 (twin)	1973-79	003-119-2
Elite 450 L/C	1978-80	003-121-8
Elite 464 L/C	1981-82	003-121-9
Everest 340	1977-79	003-119-4
Everest 440	1974-75	003-121-6
Everest 444	1980-83	003-121-1
Everest 444	1978-79	003-121-5
Everest 500	1980-83	003-121-3
Formula 500 +	1990	017-68-11
Formula 500, Dlx.	1997-99	017-72-11
Formula 583, Dlx.	1997-99	017-74-13
Formula III 600	1995-97	017-74-13
Formula III LT	1996-98	017-72-15
Formula III 600	1998	017-72-15
Formula III 700	1998	017-74-13
Formula MX	1989	017-68-11
Formula MX,LT,XTC	1985-95	017-72-11
Formula +	1985	017-70-11
Formula +, LT	1985-90	017-68-11
Formula + LT	1989	017-72-11
Formula + X	1993	017-72-11
Formula +, EFI	1993-94	017-74-11
Formula +, XTC	1991-92	017-70-11
Formula S, SL, SLS	1996-99	017-72-11
Formula SP, SS	1985-86	003-121-6
Formula SS	1995-96	017-74-13
Formula ST	1994-95	017-72-11
Formula STX	1994-96	017-74-11
Formula Z	1994-97	017-74-11
Formula Z 580,670	1998-99	017-74-13
Grand Tour. 500	1996-99	017-72-11
Grand Tour. 580	1995-96	017-74-11
Grand Tour. SE	1993-97	017-74-13
Mach I 580, 617	1989-92	017-70-11
Mach I, XTC	1993-98	017-74-13
Mach Z, LT	1994-98	017-74-13
MXZ 440F	1997-99	017-72-11
MXZ 440	1994	017-74-13
MXZ 583, 670	1996-99	017-74-13
Nordic 371,399,440	1969-72	003-119-4
Nordic 640	1970-71	003-119-6

Model	Year	Part #
Nordic 640	1972-74	003-121-7
Nordic	1981-83	003-119-3
Nordic 50	1987-91	003-121-6
Olympic 300,355,340	1970-79	003-119-4
Olympic 300,340,440	1976	003-119-5
Olympic 370,399,440	1969-74	003-119-4
Olympic + 440	1977	003-121-5
Safari 377	1984-88	003-119-4
Safari 503	1988-89	017-92-11
Safari GLX	1990-92	003-117-5
Safari Grand Luxe	1985-86	003-121-6
Safari L,LE	1990-94	003-117-4
Safari LC, LCE	1990-92	003-117-5
Safari LX, LXE	1990-91	003-117-5
Safari Rally	1993-94	003-117-4
Safari Saga Scout	1989-91	003-119-4
Safari Scout	1991-92	003-117-4
Skandic 277, 377	1982-86	003-119-3
Skandic 335	1970-73	003-119-3
Skandic 377	1986-87	017-92-11
Skandic 380, 500	1995-98	017-72-11
Skandic 380, 500	1999	017-70-11
Skandic II 377,503	1992-94	003-117-4
SS 25	1984	003-121-6
Summit 470	1994-95	017-72-11
Summit 500	1996-99	017-72-11
Summit 600	1999	017-74-13
Summit X 670	1999	017-72-11
Summit 583, 670	1995	017-74-15
TNT 292,340,440	1971-78	003-119-4
TNT 400,440,640	1972	003-121-5
TNT 440	1973	003-121-5
TNT 440 F/C	1974-78	003-121-6
TNT 640,669,775	1969-71	003-119-4
TNT 775	1972	003-121-6
TNT Everest 440	1976-79	003-121-7
TNT F/A	1973-75	003-121-4
TNT F/A 440	1977	003-121-6
TNT RV 250	1976	003-119-6
TNT RV 340	1976-79	003-121-6
Touring (all)	1996-99	017-72-11
Tundra, LT	1985-99	003-118-4
Valmont 440	1973	003-121-7

Sno-Jet

Astro SS 340,440	1975-76	003-125-4
Sabre Jet 440	1974	003-125-4
SST F/A 340,440	1975	003-125-4
SST F/C 440	1975-76	003-125-4
Whisper Jet 440	1973-75	003-125-4

Yamaha

Exciter 570,570E	1991-93	017-68-11
Mtn Max 700	1997-02	017-70-11
Phazer 480, SS	1991-98	017-64-11
Phazer ST, SSE	1991-98	017-66-11
Phazer Mtn 480	1999	017-66-11
SR 540	1991	017-68-11
SX R 700	2000-02	017-70-11
V-Max 500 DX,ST	1994-96	017-68-11
V-Max 500 XT,XTC	1997-99	017-70-11
V-Max 500 DLX,SX	1999	017-70-11
V-Max 500, 500LE	1994-96	017-68-11
V-Max 600 SX,XT,XTC	1997-99	017-70-11
V-Max 600 DLX, SX	1999	017-70-11
V-Max 700 SX	1997-99	017-70-11
Venture 500,600	1997-98	017-70-11
Venture 700	1998-02	017-70-11
Venture GT	1993	017-64-11

Silent Chain Sprockets for Arctic Cat, Polaris, John Deere

These sprockets are machined from **heat treated, case hardened metal**. A must for any performance snowmobiler or racer. Many racers in ISOC, MRP, SWDRA, Canadin Pro and USSA use these sprockets because of their durability.



11-Link Wide Sprockets

(case hardened steel)

- Fits Polaris 19994 and older, Arctic Cat 1993 and older, John Deere

Part #	Links Wide	Inner Spline	# Teeth	Price (F)
017-1117	11	13	17	\$36.12
017-1118	11	13	18	\$60.00
017-1119	11	13	19	NLA
017-1120	11	13	20	\$43.23
017-1121	11	13	21	\$60.00
017-1122	11	13	22	\$60.00
017-1123	11	13	23	NLA
017-1125*	11	13	25	\$42.92
017-1126*	11	13	26	\$60.00
017-1133	11	15	33	\$53.73
017-1134	11	15	34	\$61.38
017-1135	11	15	35	NLA
017-1136	11	15	36	\$58.64
017-1137	11	15	37	\$75.08
017-1139	11	15	39	\$75.08
017-1140	11	15	40	NLA
017-1141	11	15	41	\$66.78
017-1142	11	15	42	\$68.48
017-1143*	11	15	43	\$70.00
017-1144*	11	15	44	\$75.32

* Only fits Arctic Cat

13-Link Wide Sprockets

(case hardened steel)

- Fits Polaris 1995-2005, Arctic Cat 1993-2005

Part #	Links Wide	Inner Spline	# Teeth	Price (F)
017-1316	13	13	16	\$29.95
017-1317	13	13	17	\$52.31
017-1318	13	13	18	NLA
017-1319	13	13	19	NLA
017-1320	13	13	20	NLA
017-1321	13	13	21	\$52.31
017-1322	13	13	22	\$40.65
017-1323	13	13	23	NLA
017-1324	13	13	24	NLA
017-1325*	13	13	25	\$43.66
017-1326*	13	13	26	\$52.31
017-1333	13	13	33	\$30.77
017-1334	13	15	34	\$55.42
017-1335	13	15	35	\$81.54
017-1336	13	15	36	\$58.64
017-1337	13	15	37	NLA
017-1338	13	15	38	\$67.78
017-1339	13	15	39	\$81.54
017-1340	13	15	40	\$70.80
017-1341	13	15	41	\$81.54
017-1342	13	15	42	\$81.54
017-1343*	13	15	43	\$75.63
017-1344*	13	15	44	\$81.54

* Only fits Arctic Cat

15-Link Wide Sprockets

(case hardened steel)

- 15 inner splines fit larger jackshafts
- 13 inner splines fit older smaller jackshafts

Part #	Links Wide	Inner Spline	# Teeth	Price (F)
017-1517	15	13	17	NLA
017-1518	15	13	18	\$36.12
017-1519	15	13	19	NLA
017-1520	15	13	20	NLA
017-1521	15	13	21	\$52.31
017-1522	15	13	22	\$39.14
017-1523	15	13	23	NLA
017-1524	15	13	24	\$43.12
017-1516X	15	15	16	\$36.12
017-1517X	15	15	17	\$36.12
017-1518X	15	15	18	\$36.12
017-1519X	15	15	19	NLA
017-1520X	15	15	20	NLA
017-1521X	15	15	21	\$39.14
017-1522X	15	15	22	NLA
017-1534	15	15	34	\$60.85
017-1535	15	15	35	\$62.64
017-1537	15	15	37	NLA
017-1538	15	15	38	\$67.78
017-1539	15	15	39	\$69.29
017-1540	15	15	40	\$70.80
017-1541	15	15	41	NLA
017-1542	15	15	42	NLA

Silent Chain Sprockets for 1994-2005 Ski-Doo

These sprockets are machined from heat treated, case hardened metal. A must for any performance snowmobiler or racer. Many racers in ISOC,MRP,SWDRA, Canadin Pro and USSA use these sprockets because of their durability.



11-Link Wide Sprockets

(case hardened steel)

Part #	Width	# Teeth	Price (F)
017-1118SD	11	18	NLA
017-1119SD	11	19	NLA
017-1120SD	11	20	NLA
017-1121SD	11	21	NLA
017-1122SD	11	22	\$38.14
017-1123SD	11	23	\$39.80
017-1124SD	11	24	\$43.69
017-1125SD	11	25	\$42.92
017-1126SD	11	26	\$45.17
017-1135SD	11	35	\$58.98
017-1137SD	11	37	NLA
017-1141SD	11	41	\$69.70
017-1142SD	11	42	\$72.14
017-1143SD	11	43	NLA
017-1144SD	11	44	\$75.32

13-Link Wide Sprockets

(case hardened steel)

Part #	Width	# Teeth	Price (F)
017-1318SD	13	18	\$52.70
017-1319SD	13	19	\$52.70
017-1320SD	13	20	\$52.70
017-1321SD	13	21	\$52.70
017-1322SD	13	22	\$52.70
017-1323SD	13	23	\$52.70
017-1324SD	13	24	\$52.70
017-1325SD	13	25	\$52.70
017-1326SD	13	26	\$52.70
017-1327SD	13	27	\$52.70
017-1328SD	13	28	\$52.95
017-1329SD	13	29	\$52.95
017-1338SD	13	38	\$59.95
017-1340SD	13	40	\$77.03
017-1343SD	13	43	\$77.03
017-1344SD	13	44	\$77.03
017-1345SD	13	45	\$77.95
017-1346SD	13	46	\$78.95
017-1347SD	13	47	\$79.95
017-1348SD	13	48	\$79.95
017-1349SD	13	49	\$79.95

15-Link Wide Sprockets

(case hardened steel)

Part #	Width	# Teeth	Price (F)
017-1519SD	15	19	NLA
017-1520SD	15	20	NLA
017-1521SD	15	21	\$39.14
017-1522SD	15	22	NLA
017-1523SD	15	23	\$41.46
017-1524SD	15	24	NLA
017-1525SD	15	25	\$44.95
017-1526SD	15	26	\$45.17
017-1535SD	15	35	NLA
017-1536SD	15	36	\$58.98
017-1538SD	15	38	\$67.80
017-1541SD	15	41	\$77.97



Silent Chain Sprockets for 1994-2003 Yamaha SX and V-Max

Run the highest Quality Sprockets in the industry. "Run EPI Sprockets!" Precision Cut Sprockets machined from the highest Quality heat treated, case hardened metal. Pitch Diameter changes for every sprocket produced by EPI to insure proper chain movement. All bottom sprockets have been lightened to help decrease revolving weight. All Sprockets have a 1 year free replacement Warranty against breakage.

11-Link Wide Sprockets*(case hardened steel)*

Part #	Width	# Teeth	Price
017-1118Y	11	18	NLA
017-1119Y	11	19	\$36.12
017-1122Y	11	22	\$38.14
017-1123Y	11	23	\$39.80
017-1124Y	11	24	\$41.46
017-1137Y	11	37	NLA
017-1139Y	11	39	NLA

**13-Link Wide Sprockets***(case hardened steel 15 inner splines)*

Part #	Width	# Teeth	Price
017-1317Y	13	17	NLA
017-1318Y	13	18	\$60.00
017-1319Y	13	19	NLA
017-1320Y	13	20	\$60.00
017-1321Y	13	21	NLA
017-1322Y	13	22	\$60.00
017-1323Y	13	23	\$60.00
017-1324Y	13	24	\$60.00
017-1334Y	13	34	\$55.42
017-1335Y	13	35	\$81.54
017-1336Y	13	36	\$58.64
017-1337Y	13	37	NLA
017-1338Y	13	38	\$67.78
017-1339Y	13	39	\$81.54
017-1340Y	13	40	\$70.80
017-1341Y	13	41	\$81.54
017-1342Y	13	42	\$81.54

15-Link Wide Sprockets*(case hardened steel)*

Fits: 1998 SRX600 & 700

Part #	Width	# Teeth	Price
017-1516Y	15	16	\$36.12
017-1517Y	15	17	\$36.12
017-1518Y	15	18	\$36.12
017-1519Y	15	19	NLA
017-1520Y	15	20	NLA
017-1521Y	15	21	\$39.14
017-1522Y	15	22	NLA
017-1534	15	34	\$60.85
017-1535	15	35	\$62.64
017-1537	15	37	NLA
017-1538	15	38	\$67.78
017-1539	15	39	\$69.29
017-1540	15	40	\$70.80
017-1541	15	41	NLA
017-1542	15	42	NLA

Replacement Sprockets HRC55

- Heat treated Billet S45C Chromoly Steel.

11-Link 17/32" Wide Sprockets*for Polaris, Arctic Cat, John Deere*

- Fits 7/8" 13 spline shaft.

Part #	Links Wide	Inner Spline	# Teeth	Price
03017	11	13	17	\$19.95
03018	11	13	18	\$20.95
03019	11	13	19	\$20.95
03020	11	13	20	\$21.95
03021	11	13	21	\$21.95
03022	11	13	22	\$24.95
03035	11	15	35	\$48.95
03036	11	15	36	\$53.95
03037	11	15	37	\$57.95
03038	11	15	38	\$59.95
03039	11	15	39	\$59.95
03040	11	15	40	\$59.95
03041	11	15	41	\$64.95
03042	11	15	42	\$64.95

**13-Link 21/32" Wide Sprockets***for Polaris, Arctic Cat*

- Fits 7/8" 13 spline shaft.

Part #	Links Wide	Inner Spline	# Teeth	Price
03118	13	13	18	\$20.95
03119	13	13	19	\$20.95
03120	13	13	20	\$21.95
03121	13	13	21	\$21.95
03122	13	13	22	\$24.95
03123	13	13	23	\$24.95
03124	13	13	24	\$26.95
03125*	13	13	25	\$26.95
03126*	13	13	26	\$26.95
03135	13	15	35	\$51.95
03136	13	15	36	\$54.95
03137	13	15	37	\$57.95
03138	13	15	38	\$59.95
03139	13	15	39	\$59.95
03140	13	15	40	\$61.95
03141	13	15	41	\$64.95
03142	13	15	42	\$66.95
03143*	13	15	43	\$69.95

* Only fits Arctic Cat

13-Link 21/32" Wide Sprockets*for Polaris*

- Fits 1" 15 spline shaft.
- Fits Polaris 1995 XLT 600 Xtra; RXL Xtra, 1996-97 500cc-up

Part #	Links Wide	Inner Spline	# Teeth	Price
03318	13	15	18	\$19.95
03319	13	15	19	\$20.95
03320	13	15	20	\$21.95
03321	13	15	21	\$23.95
03322	13	15	22	\$24.95
03323	13	15	23	\$28.95
03324	13	15	24	\$29.95

13-Link 21/32" Wide Sprockets*for Ski-Doo*

- Fits 1" 15 spline shaft.
- Fits Polaris 1995 XLT 600 Xtra; RXL Xtra, 1996-97 500cc-up

Part #	Width	# Teeth	Price
03719	13	19	\$19.95
03720	13	20	\$20.95
03721	13	21	\$22.95
03722	13	22	\$24.95
03723	13	23	\$25.95
03724	13	24	\$27.95
03725	13	25	\$29.95
03726	13	26	\$33.95
03741	13	41	\$65.07
03742	13	42	\$65.93
03744	13	44	\$71.95

X-Series Sprockets for Polaris

These Sprockets will ONLY fit 1995 XLT 600 Xtra, 1995 RXL Ultra and most 1996-97 models. For 1996-97 all twins with Xtra10 use X11 wide (also 1996 XCR 600). All triples (except XCR 600) use X13 wide. All Sprockets have a one year free replacement Warranty against breakage.

New Large Jackshaft 15 Inner Spline Sprockets

Fits Polaris sleds 1996-97 (Except 1997 XC, RMK700)

11-Link Wide Sprockets

(case hardened steel)

- Fits Polaris 1996-97 sleds (except 1997 700XC, RMK)

Part #	Links Wide	Inner Spline	# Teeth	Price (F)
017-1116X	11	15	16	\$36.12
017-1117X	11	15	17	\$36.12
017-1118X	11	15	18	\$36.12
017-1119X	11	15	19	\$36.12
017-1120X	11	15	20	NLA
017-1121X	11	15	21	\$36.48
017-1122X	11	15	22	\$38.14
017-1123X	11	15	23	\$39.80
017-1124X	11	15	24	\$41.46

11-Link Wide Sprockets

(case hardened steel)

- Fits Polaris 1995 XLT 600 Xtra, RXL Xtra 1996-97 500cc-up

Part #	Links Wide	Inner Spline	# Teeth	Price (F)
017-1317X	13	15	17	NLA
017-1318X	13	15	18	\$60.00
017-1319X	13	15	19	NLA
017-1320X	13	15	20	\$60.00
017-1321X	13	15	21	NLA
017-1322X	13	15	22	\$60.00
017-1323X	13	15	23	\$60.00
017-1324X	13	15	24	\$60.00



HYVO 3/4 Sprockets for Polaris

- For 1998-05 Polaris snowmobiles. Does not interchange with any previous models. **Used with HYVO Chain only!**

Part #	Description	Price (F)
017HV17	17 tooth	\$45.95
017HV18	18 tooth	\$45.95
017HV19	19 tooth	\$45.95
017HV20	20 tooth	\$45.95
017HV21	21 tooth	\$45.95
017HV22	22 tooth	\$45.95
017HV23	23 tooth	\$45.95
017HV24	24 tooth	\$45.95
017HV25	25 tooth	\$45.95
017HV33	33 tooth	\$70.27
017HV34	34 tooth	\$70.27
017HV35	35 tooth	\$70.27
017HV36	36 tooth	\$70.27
017HV37	37 tooth	\$70.27
017HV38	38 tooth	\$70.27
017HV39	39 tooth	\$70.27
017HV40	40 tooth	\$70.27
017HV41	41 tooth	\$70.27
017HV42	42 tooth	\$70.27
017HV43	43 tooth	\$70.27
017HV44	44 tooth	\$71.95
017HV45	45 tooth	\$72.95
017HV46	46 tooth	\$72.95

HYVO 3/4 Sprockets for Yamaha

- For 2000-02 SRX, 2002-03 Viper (not RX-1) Does not interchange with any previous models **Used with HYVO Chain only!**

Part #	Description	Price (F)
YM16-34	16 tooth	NLA
YM17-34	17 tooth	\$45.95
YM18-34	18 tooth	\$45.95
YM19-34	19 tooth	\$45.95
YM20-34	20 tooth	\$45.95
YM21-34	21 tooth	\$45.95
YM22-34	22 tooth	\$45.95
YM23-34	23 tooth	\$45.95
YM24-34	24 tooth	\$45.95
YM25-34	25 tooth	\$45.95
YM33-34	33 tooth	\$70.27
YM34-34	34 tooth	\$70.27
YM35-34	35 tooth	\$70.27
YM36-34	36 tooth	\$70.27
YM37-34	37 tooth	\$70.27
YM38-34	38 tooth	\$70.27
YM39-34	39 tooth	\$70.27
YM40-34	40 tooth	\$70.27
YM41-34	41 tooth	\$70.27
YM42-34	42 tooth	\$70.27

HYVO Sprockets for Polaris and Yamaha

- Fits 1998-2004 Polaris, 2000-02 Yamaha SRX, and Viper 2002-03
- Fits 1" 15 spline 25.4 mm shaft.
- Does not interchange with any previous models. **Used with HYVO Chain only!**

Part #	# Teeth	Price	Part #	# Teeth	Price
03H17	17	\$25.95	03H25	25	\$39.95
03H18	18	\$33.95	03H35	35	\$68.95
03H19	19	\$27.95	03H37	37	\$68.95
03H20	20	\$29.95	03H38	38	\$72.95
03H21	21	\$31.95	03H39	39	\$72.86
03H22	22	\$33.95	03H40	40	\$79.95
03H23	23	\$35.95	03H41	41	\$71.95
03H24	24	\$37.95	03H42	42	\$72.95

HYVO Silent Chain 3/4"

Replacement chains for 1998-2005 Polaris snowmobiles. Does not interchange with any previous model or style. Used with 3/4 sprockets only. A great way to upgrade your Arctic Cat, or Yamaha with (The Best)

Length	Width	Part #	Price (F)
Polaris Fits 1998-2004 Models			
64 links	3/4"	HY64-34	\$128.57
66 links	3/4"	HY66-34	\$128.57
68 links	3/4"	HY68-34	\$128.57
70 links	3/4"	HY70-34	\$170.73
72 links	3/4"	HY72-34	\$170.73
74 links	3/4"	HY74-34	\$170.73
76 links	3/4"	HY76-34	\$174.62
78 links	3/4"	HY78-34	\$174.62
82 links	3/4"	HY82-34	\$174.62
86 links	3/4"	HY86-34	\$174.62
90 links	3/4"	HY90-34	\$174.62
92 links	3/4"	HY92-34	\$174.62
Yamaha Fits 2002-02 SRX, 2002-03 Viper*			
66 links	3/4"	YM66-34	\$154.11
68 links	3/4"	YM68-34	\$154.11

* Does not fit RX-1

